



D778-ET MiniPurge[®] Manual ML434



Important Note:

It is essential for safety that the installer and user of the Expo system follow these instructions.

Please refer to the standard for principles and definition.

These instructions apply only to the pressurizing system. It is the responsibility of the manufacturer of the pressurized enclosure to provide instructions for the enclosure.

Expo Technologies reserves the right to replace any component, with one of the equivalent functionality.



CONTENTS

Section 1: System Specification	3
MiniPurge® Control Unit Data	4
Relief Valve Unit and Purge Outlet Valve with integral spark arrestor	5
Section 2: Quick User Guide	6
Installation	6
Operation of the System	6
Section 3: Application Suitability	7
Section 4: Description and Principle of Operation	8
Section 5: Main Components	9
Air Supply Filter / Regulator	9
Logic Air Supply Regulator	9
Minimum Pressure Sensor	9
Purge Flow Sensor	9
Intermediate Sensor	9
Electronic Purge Timer	9
Purge Complete Valve	10
OR Gate	10
Alarm Only Circuit (/AO)	10
Visual Indicators	10
Power Interlock Switch	10
Alarm / Pressurized Switch	10
System Purging Switch (Optional)	11
Intermediate Switch	11
Purge Valve	11
Purge Flow Restrictor	11
CLAPS Sensor	11
CLAPS Regulator	11
Relief Valve Unit	11
/PA Terminal Box	11
Section 6: Installation of the System	12
Installation of the System	12
Relief Valve Unit	12
Air Supply Quality	12
Pipe Work	13
Multiple Enclosures	13
Provision and Installation of Alarm Devices	13
Power Supplies and their Isolation	13
Power Interlock Switch	13
Section 7: Commissioning	14
Commissioning the System	14
Normal Operation	16
Section 8: Maintenance of the System	16
General maintenance	16
Additional maintenance checks	16
Maintenance of Electronic Timer	16
Re-calibration of the Relief Valve Unit	17
Re-calibration of the Pressure Sensors	17
Section 9: Fault Finding	18
General Information	18
System purges correctly but trips and auto re-purges at the end of the purge time	19
Relief Valve opens (continuously or intermittently)	19
System enters purging but purge indication does not occur	19
System begins purging but cycles fail to complete	19
Flow restrictor ball valve opens/closes by itself	19
Section 10: Recommended Spares List	20
Section 11: Glossary	20
Section 12: Drawings and Diagrams	20
Section 13: Certifications	21



Section 1: System Specification

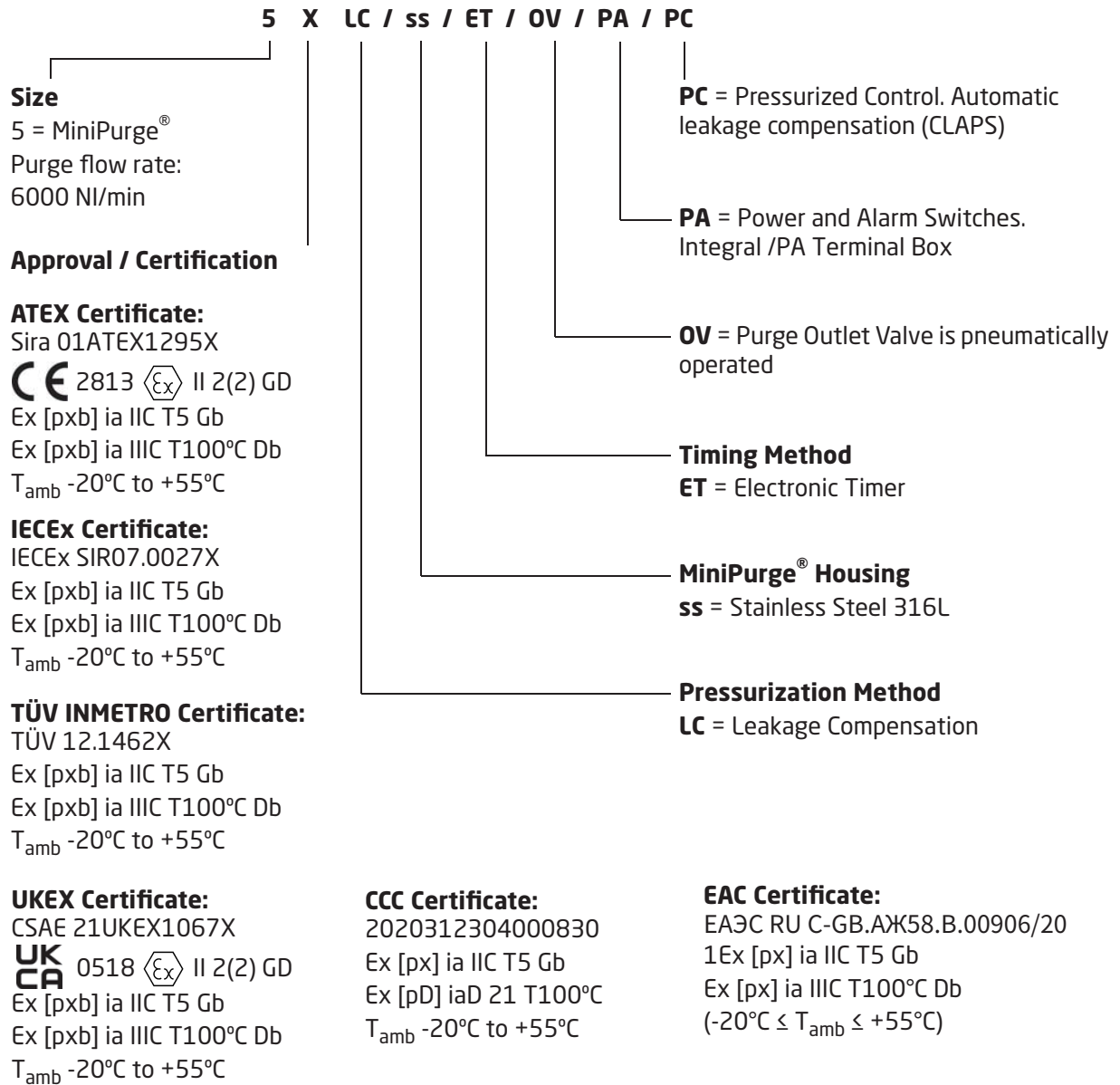

APPLICABLE SPECIFIC CONDITIONS OF USE:

1. The installer/user shall ensure that the MiniPurge Control Unit is installed in accordance with the equipment certificate that covers the combination of the pressurised enclosure(s) and MiniPurge Control Unit.
2. The values of the safety parameters shall be set in accordance with the equipment certificate that covers the combination of the pressurised enclosure(s) and MiniPurge Control Unit.
3. This MiniPurge Control Unit shall be incorporated into equipment and the appropriate Conformity Assessment Procedures applied to the combination, as defined by IECEx rules, Directive 2014/34/EU or UKCA Regulations, as applicable.

For further details refer to the applicable certificates.



MiniPurge® Control Unit Data

Action on Pressure Failure:	Alarm and Trip (isolate power to pressurized enclosure), user adjustable Alarm Only.
Type of Operation:	Automatic leakage compensation using the Closed Loop Automatic Pressurization System (CLAPS System).
Leakage Compensation Capacity	1500 NI/min max.
Enclosure Material:	Stainless Steel 316L.
Mounting Method:	Wall mounting straps. Fixing holes as per drawing.
Temperature Limits:	-20°C to +55°C
Compressed Air Supply:	Clean, dry, oil free air or inert gas. Refer to Air Supply Quality section in Installation of the System.
Supply Pressure:	5 to 16 barg (73 to 232 psi).
Main Regulator:	Set at 5 barg, 40 µm automatic drain supply inlet filter.
Logic Regulator and Gauge:	Fitted and set to 2.5 barg (36 psi).
Process Connections:	Purge supply and outlet to pressurized enclosure 1" NPT female. Minimum supply line 25 mm (1") ID tube, inlet sized appropriately for flow rate. Reference points & signals 1/8" NPT female, minimum 6 mm pipe to be used.
Visual Indicators:	Alarm (Red ●) / Pressurized (Green ●). System Purging: 4 LEDs that flash sequentially to indicate elapsed time (black when not purging).
/PA Terminal Box:	Stainless Steel, Ex e IIC T5 Gb / Ex tb IIIC T100°C Db IP66 Tamb : -20°C to +55°C with terminals, front access cover & lower removable gland plate. Stainless Steel, Ex e IIC T4 Gb Tamb : -20°C to +60°C with terminals, front access cover & lower removable gland plate. For user instruction manual refer to ML358, attached to the manual.
Power Interlock Switch:	DPNO switch, contact ratings 250 Vac 4 Amps (AC-15) / 24V DC 4A, Ex d IIC T6 Gb / Ex tb IIIC T80°C Db.
Alarm Switch:	SPCO switch, contact ratings 250 Vac 4 Amps (AC-15) / 24V DC 4A, Ex d IIC T6 Gb / Ex tb IIIC T80°C Db.
Intermediate Switch:	SPCO switch, contact ratings 250 Vac 4 Amps (AC-15) / 24V DC 4A, Ex d IIC T6 Gb / Ex tb IIIC T80°C Db.
System Purging Switch (Optional):	SPCO switch, contact ratings 250 Vac 4 Amps (AC-15) / 24V DC 4A, Ex d IIC T6 Gb / Ex tb IIIC T80°C Db.
Minimum Pressure Sensor:	Minimum: 0.5 mbarg. Maximum: 5.0 mbarg. Default Setting: 1.5 mbarg. Tolerance -0, +0.7 mbarg.
Intermediate Sensor:	Minimum: 2.0 mbarg. Maximum: 10 mbarg. Default Setting: 5.0 mbarg. Tolerance: -0, +10%.



Note: There must be a 1.5 mbarg difference between the minimum pressure and intermediate sensors.

Purge Flow Sensor: Set at 6.4 mbarg (Tolerance: -0, +10%).

CLAPS Sensor: Minimum: 5.0 mbarg.
Maximum: 15 mbarg.
Default Setting: 10 mbarg.
Tolerance: -0, +10%

**Note: there must be a 2.5 mbarg difference between the intermediate and CLAPS sensor calibration point.
For example: Minimum pressure = 5 mbarg, intermediate pressure = 6.5 mbarg, CLAPS sensor = 9 mbarg.**

Purge Time: User selectable, in 1 minute intervals, up to 99 minutes (tolerance -0, +3 seconds).
Default Setting 99 minutes.

Weight: 27 kg (60lb).

Relief Valve Unit and Purge Outlet Valve with integral spark arrestor

Type: RLV104/ss/FS, Design number D758RLV.

Bore: Purge Outlet Valve Ø 104 mm, Relief Valve Ø 75 mm.

Relief Valve Lift-Off Pressure: Minimum: 20 mbarg.
Maximum: 50 mbarg.
Default: 30 mbarg (+0, -20%).

Flow Rate: Range: 2000, 3000, 4000, 5000, or 6000 NI/min.
Default: 2000 NI/min.

Material: Housing: Stainless steel 316L.
Gasket: Silicone foam.
Spark arrestor: Stainless steel mesh.

Mounting Method: Rectangular cut-out and fixing holes as per drawing.

Weight: 7 kg (15.4 lb).

Note: Special settings available on request, refer to Test and Inspection Sheet.



Section 2: Quick User Guide

Installation

The MiniPurge[®] system must be installed by a competent engineer, in accordance with relevant standards, such as IEC / EN 60079-14 and any local codes or practice.

- Mount the purge system in accordance with the hook-up drawing.
- Ensure the system is installed according to the full instructions in the “Installation of the System” section of this manual.
- All piping must be clean and free of dirt, condensation and debris prior to connection to the purge system or pressurized enclosure.
- It is strongly recommended that a local isolation valve is installed on the air supply upstream of the purge system.

Note: Most faults are due to restricted air supply, inadequate supply pipe work or drop in air supply pressure during the purge process.

Operation of the System

Once the system is installed correctly, turn on the air supply. Refer to Commissioning section.

Indicator	Colour	Status
Alarm / Pressurized	Red ●	Low pressure alarm (enclosure pressure too low)
Purging	Black ●	Purge flow too low or not in purge mode

The purge system commences the purge cycle:

- The purge air will enter the enclosure.
- The pressurized enclosure will obtain a positive pressure.
- The Purge Outlet Valve will open within the Relief Valve Unit.
- The air will then exit the Relief Valve Unit housing via the spark arrestor.

Indicator	Colour	Status
Alarm / Pressurized	Green ●	Pressurized (minimum enclosure pressure achieved)
Purging	Black ●	Purge flow too low

Open the Purge Flow Restrictor Valve until the air flow reaches the required rate; the system will initiate the timed purge cycle. Start a stopwatch when the purging indicator flashes yellow.

Indicator	Colour	Status
Alarm / Pressurized	Green ●	Pressurized
Purging	Sequential flashing Yellow ●	Purge flow rate above minimum

On completion of an uninterrupted purge cycle of the required length, the system will indicate purge complete.



Stop the stopwatch when the purging indicator stops flashing.

Indicator	Colour	Status
Alarm / Pressurized	Green ●	Pressurized and in leakage compensation mode
Purging	Black ●	No longer in purge mode

Check stopwatch timing to verify that the actual purge time is equal to or greater than the required purge time.

Note: The recorded purge time must never be less than the required purge time.

The system is now operating correctly in leakage compensation mode.

If the system has not performed as expected, check the installation thoroughly and ensure it has been carried out according to the instructions.

If an obvious problem has not been highlighted and corrected, follow the procedures in the Fault Finding section.

If all checks have been carried out and the system still does not perform as expected, contact your local distributor or Expo Technologies.

Section 3: Application Suitability

MiniPurge® systems are certified for use in hazardous locations, where the hazardous location is non-mining (above ground) and the hazard is caused by flammable gasses, vapours or dust. Depending on the model the systems may be used in IECEx and ATEX Zone 1 and/or Zone 2 - Categories 2 and 3 respectively.

MiniPurge® systems may be used for hazards of any gas group. Apparatus associated with the MiniPurge® system, such as intrinsically safe signalling circuits and flameproof enclosures containing switching devices may be limited in their gas group. The certification documentation supplied with any such devices must be checked to ensure their suitability.

This system is primarily designed for use with compressed air. Where other inert compressed gasses are used (Nitrogen, for example) the user must take suitable precautions so that the build up of the inert gas does not present a hazard to health. Consult the Control of Substances Hazardous to Health (COSHH) data sheet for the gas used. Where a risk of asphyxiation exists, a warning label must be fitted to the pressurized enclosure.

The following materials are used in the construction of MiniPurge® systems. If substances that will adversely affect any of these materials are present in the surrounding environment, please consult Expo Technologies for further guidance.

Materials of Construction		
Stainless Steel	Aluminium	Acrylic
Mild (Carbon) Steel	Nylon	Silicone
Brass	Polyurethane	Neoprene
ABS	Polycarbonate	Polyester (glass filled)



Section 4: Description and Principle of Operation

The MiniPurge® system is pneumatic in operation, with electrical interfaces.

Purge and pressurization is a method of protection used in Zone 1 (21) and/or Zone 2 (22) hazardous locations to ensure that the interior of an enclosure is free of flammable gas. Addition of a MiniPurge® system allows the electrical equipment within the enclosure to be used safely in a hazardous location.

The principle of purge and pressurization is as follows:

- Clean compressed air or inert gas is drawn from a non-hazardous location.
- The interior of the pressurized enclosure is flushed to remove any hazardous gas or dust.
- This is introduced into the pressurized enclosure to keep the internal pressure at least 0.5 mbarg above the external pressure.
- Whilst pressurized, flammable gas cannot enter the enclosure from the environment.

Prior to switching on the power to the electrical equipment, the enclosure must be purged to remove any flammable gas that might have entered the enclosure before pressurization. Purging is the process of removal contaminated air and replacement with air (or inert gas) known to be free from flammable gas. The duration of this purge process is normally ascertained by performing a purge test.

At the end of the purge cycle the system automatically switches to leakage compensation mode. The Purge Outlet Valve is closed and the airflow is reduced but remains high enough to compensate for the leakage of air from the enclosure whilst maintaining the minimum over pressure state.

In the event of pressure failure within the pressurized enclosure the system will raise an alarm in the form of visual indicators and a volt free contact depending on the specification of the system. The default action on loss of pressurization is alarm and automatic disconnect of power (A&T - Alarm and Trip). This can be changed by the customer to Alarm Only (/AO), please refer to section titled Main Components.

The MiniPurge® system incorporates a Closed Loop Automatic Pressurization System (CLAPS). This allows the system to detect a rise or fall of the enclosure's internal pressure and adjust the leakage compensation rate accordingly. Pressure variations are more likely during sudden start up of large rotating electrical machines but can also be caused by changes in running temperature. This system has been specifically designed to maintain a stable internal pressure within the enclosure.

Pressure characteristics during purge and pressurization of a pressurized enclosure using a MiniPurge® system that incorporates a CLAPS system:

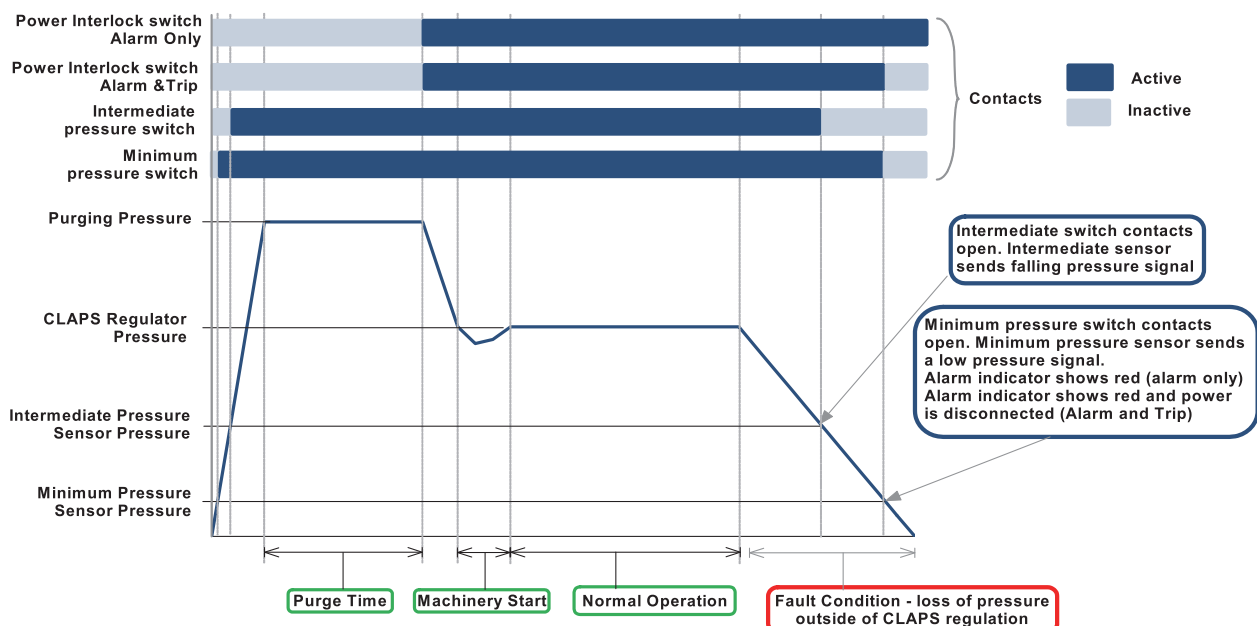



Section 5: Main Components

Air Supply Filter / Regulator

The unit is provided with a 40 µm liquid / dust filter element as a precaution. The user of the MiniPurge® system must ensure that air supply is to the quality stated in Air Supply Quality paragraph found in the Installation of the System section. The regulator is factory set to 5 barg (73 psig) and regulates the pressure of an air supply between 5 and 16 barg (73 to 232 psig). A pressure gauge is fitted down stream of the filter; this should indicate no less than 5 barg (73 psig). During the purge cycle a pressure drop will be indicated on the gauge.

Logic Air Supply Regulator

This device provides the system with a stable air supply pressure to the logic system and allows consistent operation. The pressure level is factory set to 2.5 barg (36 psig) and can be verified by means of the integral pressure gauge.

Minimum Pressure Sensor

This monitors the pressure inside the pressurized enclosure. When the pressure is below the minimum required for safe operation, the pressure sensor causes the system to reset and the Alarm / Pressurized indicator turns **Red** ●. The sensor is factory calibrated and set to operate in falling pressure at or above the minimum specified pressure.

Purge Flow Sensor

The Purge Flow Sensor monitors flow through the Purge Outlet Valve. At correct purge flow rates, above the minimum specified for purging, the sensor sends a signal that activates the purge timer. This sensor is factory calibrated to operate on falling flow rate at or above the minimum specified purge flow rate.

Intermediate Sensor

This sensor monitors the pressure inside the pressurized enclosure. It senses when the pressure is drops and provides early warning before the low pressure sensor trips the system.

Electronic Purge Timer

When both the enclosure pressure and the purge flow rate are correct, the Purge Flow Sensor activates the timer and the electronic timer starts. The timing period is selected using switches mounted on the timer module.

Note: Setting the timer to 00 minutes will cause infinite purging; the cycle will never complete.

During timing, the percentage of the purge cycle is indicated by four LEDs which flashes sequentially while the timer is running.

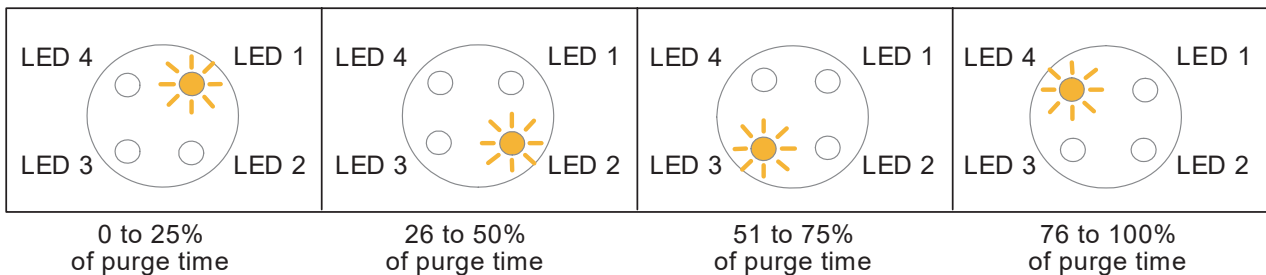

The Electronic Timer contains an intrinsically safe battery pack that needs regular replacement. See Commissioning section.



Purge Complete Valve

This valve receives a signal from the purge timer that indicates the completion of the purge cycle and verifies that the pressurization signal is still present. If both conditions are satisfied a signal is sent to indicate that the purge is complete. This performs two functions: to turn on the electrical supply to the pressurized enclosure and to reduce the high purge flow rate to leakage compensation mode. It also provides a hold-on signal that maintains the leakage compensation mode with the power switch on, even when the purge timer has reset ready for the next purge cycle.

OR Gate

This device provides the Purge Complete Valve with the hold-on function referred to previously. When either the timed-out signal or the purge complete signal is present it allows the pilot signal to be sent to the purge complete valve.

Alarm Only Circuit (/AO)



If the pressure in the pressurized enclosure is too low the system will normally cut off electrical power to it. In certain circumstances, where local codes of practice allow, the system can be altered to provide a hold-on circuit that will maintain the electrical power supply to the pressurized enclosure while also providing a pressure failure alarm. The user must respond to the alarm and either restore the pressure to the pressurized enclosure or otherwise make the installation safe; for example, cut off the electrical supply. The decision to use the Alarm Only facility, and the allowable length of time for non-pressurized operation, is the responsibility of the user.

Warning: It is potentially dangerous to energise the pressurized enclosure in a non-pressurized condition when it is known that there is potentially explosive gas or dust in the hazardous location.



Visual Indicators



Visual indicators are fitted to provide status information to the operator.

Alarm / Pressurized Indicator

Green*		Pressurized
Red		Pressure Alarm (enclosure pressure low)

System Purging Indicator

Black*		Purge flow too low (not in purge mode)
Yellow (flashing)		Purging (flow above minimum)

* The Green  / Black  combination indicates normal operation of the pressurized enclosure after the initial purging cycle has been completed.

Power Interlock Switch

This flameproof switch is used as simple apparatus for connection to intrinsically safe circuits only. It is activated by the signal from the purge complete valve. This activation can be used to turn on the electrical supply to the pressurized enclosure. The cable from the switch is terminated on the Intrinsically Safe terminal box.

Alarm / Pressurized Switch

This flameproof switch is used as simple apparatus for connection to intrinsically safe circuits only. It is operated by the pressurized signal. It allows remote electrical system status indicator to show either pressurized or a pressure failure alarm. The cable from the switch is terminated in the Intrinsically Safe terminal box.



System Purging Switch (Optional)

This switch is operated by the purge flow signal that allows a remote electrical system status indicator to signal that the system is purging; sometimes referred to as “purge-in-progress”. The cable from the switch is terminated in the /PA terminal box.

Intermediate Switch

This is a flameproof switch which is activated by the signal from the Intermediate Sensor. The cable from the switch is terminated in the /PA terminal box.

Purge Valve

This changeover valve selects between purge air flow or leakage compensation. It is sized to allow sufficient air into the enclosure during purging based on: the specified air supply pressure range, the minimum specified purging outlet flow rate +10% and the expected leakage rate from the pressurized enclosure. At the end of the purge cycle, the purge valve closes in response to the “Purge Complete” signal; it remains in the closed position until the next purge cycle is initiated.

Purge Flow Restrictor

This valve restricts the purge flow to the minimum required flow rate. The Purge Flow Restrictor must be readjusted during commissioning.

CLAPS Sensor

This sensor monitors the pressure within the pressurized enclosure and sends a control signal to the CLAPS Regulator. The normal running pressure must be determined prior to system start-up so that the CLAPS Sensor may be set to the level required to control the CLAPS Regulator.

CLAPS Regulator

This is the regulator that controls the leakage compensation air flow into the enclosure after the purging is complete. It either increases or decreases the air flow into the enclosure as appropriate to maintain a stable running pressure. The CLAPS Regulator must be set at the time of commissioning.

Relief Valve Unit

The Relief Valve Unit allows the purge air to exit the enclosure safely via a built-in spark arrestor. This spark arrestor is designed to prevent the emission of arcs, sparks and incandescent particles produced within the pressurized enclosure.

Purge air passes through the Relief Valve Unit; the preset pressure differential across the appropriate orifice ensures that the purge flow sensor is activated once the selected purge flow has been attained.

During the purge cycle a pneumatic cylinder operates the Purge Outlet Valve that lets the air from inside the enclosure exhaust through the Relief Valve Unit. When the system changes to leakage compensation mode, the Purge Outlet Valve is closed and the enclosure sealed.

The Relief Valve Unit has an in-built relief valve. This is sized to ensure that, if the air supply pressure rises up from the specified maximum, the internal enclosure pressure will not exceed the specified maximum working pressure of the pressurized enclosure.

/PA Terminal Box

The Terminal Box is increased safety (Ex e) certified and incorporates the terminal connection points for the alarm and interlock switches. All contacts provided are volt free (dry).

Cable entry methods (for example conduit or cable glands) must also be certified to IECEx, ATEX and/or INMETRO standards (and must match the certification scheme for the motor). The main requirement is that IP66 (or better) ingress protection must be provided by use of seals or washers.



Section 6: Installation of the System

The MiniPurge® is designed for use under normal industrial conditions of ambient temperature, humidity and vibration. Please consult Expo before installing this equipment in conditions that may cause stresses beyond normal industrial conditions. The MiniPurge® system must be installed by a competent person in accordance with relevant standards, such as IEC / EN 60079-14, and any local codes of practice.

The MiniPurge® control unit should be installed either directly on, or close to the pressurized enclosure. It should be installed such that the system indicators and certification labels are in view.

All parts of the system carry a common serial number. If installing more than one system, ensure that this commonality is maintained within each system installed.

Relief Valve Unit

To achieve effective purging, the points where air enters and exits the pressurized enclosure should normally be at opposite ends of the enclosure. The RLV unit must be mounted vertically and there should be a minimum clearance of 300 mm (12") around the spark arrestor (purge outlet).

It is important that the interior and exterior of the spark arrestor is kept clean and debris is not allowed to accumulate; this might affect the calibration of the device. In particular, the exterior of the spark arrestor should not be painted or blocked in any way.

Air Supply Quality

The MiniPurge® system should be connected to a protective gas supply, which is suitable for purging and pressurization.

The supply pipe connection to the MiniPurge® must be appropriate for the maximum input flow rate for the application.

The air supply must be regulated at a pressure less than the maximum stated inlet pressure.

The air supply must be: clean, non-flammable and from a non-hazardous location. The air should be of Instrument Air Quality. Although the purge control system will operate with lower air quality, its operational life will be adversely affected. The equipment that is being protected by the MiniPurge® may also suffer because of poor air quality.

With reference to BS ISO 8573-1: 2010, Instrument Air is typically specified as:

Particle Class 1

In each cubic metre of compressed air, the particulate count should not exceed 20,000 particles in the 0.1 to 0.5 micron size range, 400 particles in the 0.5 to 1 micron size range and 10 particles in the 1 to 5 micron size range.

Humidity or pressure dew point

The dew point, at line pressure, shall be at least 10 °C below the minimum local recorded ambient temperature at the plant site. In no case, should the dew point at line pressure exceed +3 °C.

Oil Class 2

In each cubic metre of compressed air, not more than 0.1mg of oil is allowed. This is a total level for liquid oil, oil aerosol and oil vapour.



When an inert gas is being used to supply the purge system, risk of asphyxiation exists. Refer to Application Suitability section.

Before connection of the air supply to the purge system, the supply pipe work should be flushed through with instrument quality air to remove any debris that may remain in the pipes. This must be carried out for at least 10 seconds for every meter of supply pipe.

Unless a supply shut-off valve has been fitted to the MiniPurge® system, an external shut-off valve with the same, or larger, thread size as the Control Unit inlet fitting should be fitted by the installer to prevent any restriction of purge flow.

The purge air from the MiniPurge® Control Unit should be piped within the pressurized enclosure to ensure purging of potential dead air spots.

The purge system is fitted with an internal regulator factory set to 3 bar feeding the logic.

Pipe Work

If the MiniPurge® is not connected directly to the pressurized enclosure, pipe work and fittings used to connect the Control Unit to the pressurized enclosure should be either metallic or appropriate to the environment into which the system is installed. No valve may be fitted in any signal pipe connecting the Control Unit to the pressurized enclosure. This pipe work must be fitted in accordance with local codes of practice where relevant.

Multiple Enclosures

This system is suitable for the purge and pressurization of the primary pressurized enclosure and its associated terminal boxes.

Provision and Installation of Alarm Devices

When the pressure inside the pressurized enclosure is above the minimum, the Minimum Pressure Sensor returns a positive (pressurized) signal causing the alarm indicator on the control unit to change from red to green.

When the pressure falls below the minimum permissible the positive (pressurized) signal is removed. This absence of signal indicates a low pressure alarm condition and causes the alarm indicator on the control unit to go from green to red.

There are volt free (dry) contacts available within the terminal box for remote usage.

The user must make use of this alarm facility in accordance with the local code of practice for Action on Pressure or Flow Failure. Most codes include the following recommendations:

- Zone 1 Installations: Alarm and Automatic Trip of Power.
- Zone 2 Installations: Alarm Only on pressure or flow failure with power being removed manually.

Power Supplies and their Isolation

All power entering the pressurized enclosure should have a means of isolation. This requirement also applies to any external power sources that are connected to the equipment such as volt-free (dry) contacts within the pressurized enclosure. This is commonly achieved using the Power Interlock Switch.

Power Interlock Switch

This switch is a Double Pole Normally This switch is a Double Pole Normally Open, double-break switch: it provides two independent contacts that should be connected in series and used to isolate the power. This can be achieved using suitable certified intrinsically safe barriers. These contacts are terminated and accessible to the user in the terminal box.

It is the responsibility of the user to ensure that the switch is only operated within appropriate technical limits.



The switch must be replaced after any short circuit that occurs within the main circuit; the switch is a piece of encapsulated equipment and as such it is not possible to check the state of the contacts. Technical modifications to the switch are not permitted.

Prior to commissioning, check that the terminal box is clean, the connections have been made properly, the cables laid correctly and all screws in the terminals are secure.

In all cases the application and isolation of power must be controlled by the MiniPurge® system using the power interlock signal.

No switches are permitted between the power switch and the MiniPurge® system other than an authorized manual override circuit.

The safe use of this switch is the responsibility of the user, all electrical installations must conform to local codes of practice.

Exception

Power to apparatus that is already suitable for use in hazardous locations need not be isolated by the MiniPurge® system.

Section 7: Commissioning

Commissioning the System

Note: The steps 11 and 15 to 21 represent detailed commissioning tests

The following equipment is needed for this process:

- Continuity meter
- Gauge manometer (0 to 200 mbarg)
- Differential manometer

If, after commissioning, the system does not perform as expected, refer to the Fault Finding Section.

Follow the steps as outlined:

1. Check all connections and that the Relief Valve Unit is fitted correctly with an unobstructed path to the purge exhaust.
2. Close the Purge Flow Restrictor Valve.
3. Fully open external supply shut-off valve where fitted.
4. Check that the internal logic pressure gauge reads 2.5 barg / 36 psi / 250 kPag.
5. Check that the pressure gauge on main air supply reads 5 barg / 73 psi / 500 kPag.
6. Check that the Pressure Relief Valve is correctly set by disconnecting the minimum pressure sensing pipe at the bulkhead fitting on the input to the MiniPurge®. This will disable all of the pressure sensors.
 - Using a 4 mm nylon tube, connect a manometer to the bulkhead fitting from which the minimum pressure sensing pipe was removed.
 - Open the Purge Flow Restrictor Valve very slowly, until the Pressure Relief Valve opens
 - Check the opening pressure is within calibration limits.
 - This test can be carried out several times to ensure repeatability and compliance.Refer to the Maintenance of the System section if the Relief Valve needs recalibrating.
7. Close the Purge Flow Restrictor Valve.
8. Remove the manometer and reconnect the minimum pressure sensing pipe to the bulkhead fitting.
9. Remove red plug from the top of the Minimum Pressure Sensor and connect a gauge manometer.



10. Connect a differential manometer to the test points on the flow sensor.
11. To check sensor calibration
 - The internal pressure in the pressurized enclosure must be below Relief Valve lift off pressure and above the CLAPS pressure
 - At this time the pressurized indicator should be **green**.
 - gradually open Purge Flow Restrictor Valve until purging indicator **flashes yellow**.

Note: For large volumes it may take a long time for the purge flow to start.

 - very slowly close Purge Flow Restrictor Valve until the purging indicator stops **flashing yellow**.
 - Take a reading from pressure gauge.
12. To set the purge flow rate:
 - Turn on the compressed air to the MiniPurge®.
 - Gradually open the Purge Flow Restrictor Valve until the **black / yellow** indicator changes to **yellow (flashing)**.
 - The flashing yellow indicator confirms the correct flow rate.
 - The differential pressure should be greater than 6.4 mbarg.
 - The relief valve is supplied with different orifice plates for the specified flow rate. This orifice plate is held in position by two M3 screws and can easily be changed by removing the large cover plate from over the outlet valve assembly and screws.

Warning: When opening the Purge Flow Restrictor Valve, ensure the over pressure within the pressurized enclosure does not exceed the pressure relief valve setting.
13. The purge timer will start as soon as the Purging Indicator **flashes yellow**. Check that the time delay between the indicator turning to **yellow (flashing)** and returning to **black** is not less than the minimum time required for complete purging of the pressurized enclosure. Times in excess of minimum are permitted.
14. After the purge has been completed, the Purge Valve will close and the air flow into the pressurized enclosure will be controlled by the CLAPS Regulator. The initial setting may be too high or too low.
15. Gradually turn the CLAPS Regulator anti-clockwise to reduce enclosure pressure.
16. Reduce regulator until intermediate sensor causes contacts to open.
17. Check the manometer on the minimum pressure sensor.
18. Continue to reduce the CLAPS Regulator to test the minimum pressure sensor.
19. To check operation of Minimum Pressure Sensor, check readings on manometer as system will automatically re-purge when it reaches minimum pressure.
20. While the system re-purges, return the CLAPS Regulator to the initial setting.
21. If minimum pressure is below the set point, refer to the Recalibration section
22. If the setting is too high, continual rising and falling of the enclosure pressure will be seen as the CLAPS Regulator automatically shuts off and reinstates the flow. The CLAPS Regulator should be adjusted to reduce the flow into the pressurized enclosure by turning the adjuster screw anti-clockwise.
23. If the initial setting is too low the CLAPS Regulator may not provide enough air flow causing a gradual decline in enclosure pressure. To increase the flow into the pressurized enclosure, adjust the CLAPS Regulator Relief Valve unit by turning the adjuster screw clockwise.
24. To test the CLAPS settings, create a leak in the system by removing a bolt or loosening a gland plate in order to create a 15mm hole. Remember to replace bolt or retighten gland plate after testing.
25. The setting of the CLAPS Sensor is factory calibrated to the normal working pressure expected in the pressurized enclosure, typically 10 mbarg. The pressure in the pressurized enclosure should be stabilized



as close as possible to this figure. This can be checked by a manometer attached to the minimum pressure sensor.

26. Tighten locknut on flow restrictor to 2.5 N/m².

27. Remove the air supply to the system, remove all test equipment and replace all plugs.

Normal Operation

For normal operation of the system, after commissioning has been carried out it is possible to turn the air supply valve on or off to start or stop the system. After this, the purge and pressurization sequence is automatic.

Section 8: Maintenance of the System

General maintenance

The maintenance of the system outlined in this manual should be supplemented with any additional requirements set out in appropriate local codes of practice.

The following checks should be carried out every 6 - 36 months dependent on environment according to IEC / EN 60079-17

- Tests outlined in the Detailed Commissioning section.
- Ensure that the Relief Valve Unit is free from contamination prior to making any adjustment. To do this:
 - Remove large cover plate using a 8 mm spanner (wrench).
 - Check that the interior and all components are clean and free from contamination.
 - Replace large cover plate.
- Check the condition of the air supply filter element. Clean or replace as necessary.

Additional maintenance checks

The following additional checks are recommended at least every 3 years:

Check that:

- Apparatus is suitable for use in the hazardous location.
- There are no unauthorised modifications.
- The air supply is uncontaminated.
- The interlocks and alarms function correctly.
- Approval labels are legible and undamaged.
- Adequate spares are carried.
- The action on pressure failure is correct.

Maintenance of Electronic Timer

This should be carried out every 3 years.

- The intrinsically safe battery pack associated with the electronic timer should be replaced and the commissioning tests repeated.
- After the timing phase has elapsed, the battery may be hot-swapped in the hazardous location without affecting the operation of the MiniPurge® system

Re-calibration of the Relief Valve Unit

Warning

Incorrect adjustment of the Relief Valve Unit can lead to significant over pressure and result in damage to the enclosure.

If maximum pressure setting is reached, stop adjustment, and reduce the pressure.

To perform the following adjustments, an 8 mm spanner (wrench) and a 2.5 mm hex key will be required. Ensure that the Relief Valve Unit is free from contamination prior to making any adjustment. To do this:

- Remove large cover plate using an 8 mm spanner (wrench).
- Check that the interior and all components are clean and free from contamination.
- Replace large cover plate

To adjust the lift off pressure of the Relief Valve:

- Attach test equipment as described in the Commissioning Section.
- Remove small cover plate.
- Whilst holding the central adjustment screw in position using the hex key, loosen the retaining nut.
- Adjust the hex key clockwise to increase, or anti-clockwise to reduce the lift off pressure.
- Before testing, retighten the locking nut whilst holding the adjustment screw in place.
- Carry out the commissioning tests to check the correct setting of the relief valve after adjustment.
- The adjustment is sensitive, and it is recommended that a 1/4 turn (maximum) adjustments are applied between tests.

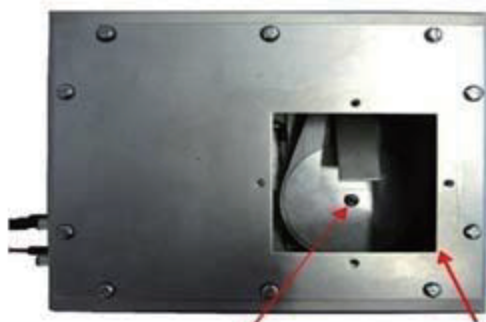

Allen Screw and Lock NUT
Removing the small cover plate to set the RLV opening pressure

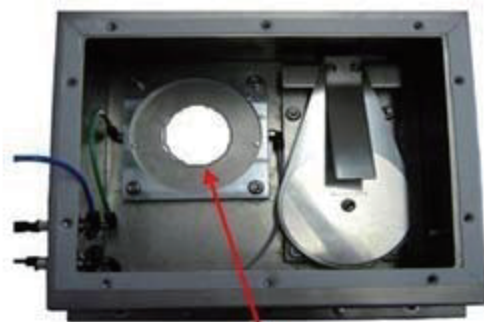

Orifice Plate

Re-calibration of the Pressure Sensors

The brass nozzle on the sensor is sealed into position using Loctite thread sealant. If the thread has seized up, remove to a safe area and heat slightly to soften prior to making any adjustment. This prevents potential damage to the brass of the nozzle.

- Disconnect pipe work from the sensor, including pipe located below the sensor.
- Remove sensor by unscrewing anti-clockwise.
- The nozzle is located under the sensor.
- The adjustment is sensitive, turn the nozzle in 1/8 of a turn step.
- Turn clockwise to reduce the pressure setting and anti-clockwise to increase.
- Replace sensor, screwing clockwise.
- Reconnect all pipe work.



Section 9: Fault Finding

General Information

If you are having problems that cannot be corrected using one of the methods described, please call Expo or your supplier for further assistance. If the system is less than 12 months old, parts under warranty should be returned to Expo for investigation. A full report of the fault and the system serial number should accompany the parts.

It is common for problems with the MiniPurge® system to be caused by contamination of the air supply with oil, water, or dirt. To prevent these problems, the air supply must contain a dust filter and a water filter. This will ensure that the air is instrument quality and protect both the purge system and the equipment being purged. This filtration system is not provided by Expo and must be sourced separately.

Contamination can enter the system from a number of sources. To prevent this, it is essential that the procedures described in the Installation section are carried out prior to first use of the system. These procedures should also be carried out following any disconnection and re-connection of the pipe work. Failure to perform these procedures may cause damage to the system that will not be covered by the warranty. The system has been designed for ease of fault finding and many of the components fitted are plug-in or chassis mounted. Check components by substitution only after establishing that such action is necessary.

Before carrying out the fault finding procedures, ensure that:

- Both the main air pressure to the system and for Motor Purge Systems, the regulated pressure to the logic manifold are as specified on the settings sheet.
- Air pressure does not drop below the minimum supply pressure during purging; most faults reported are due to insufficient air supply during the purge cycle.

System purges correctly but trips and auto re-purges at the end of the purge time.

This is a result of the pressure within the pressurized enclosure being below the minimum pressure sensor setting. The pressure can be checked using a manometer. The most common causes of this problem are outlined below.

Fault Location	Cause	Solution
Pressurized Enclosure	There is debris on the face of the Relief Valve disk held in place by the magnet.	<ul style="list-style-type: none"> • Remove debris and ensure RLV disk is clean.
	Enclosure leaking excessively.	<ul style="list-style-type: none"> • Ensure all doors and covers are closed and that all conduit and cable glands are properly sealed. • Seal any other leaks.
	Pressure sensing tube damaged.	<ul style="list-style-type: none"> • Replace tubing.
CLAPS Regulator	The CLAPS Regulator setting is too low.	<ul style="list-style-type: none"> • Increase the setting of the CLAPS regulator to raise the pressure in the pressurized enclosure after purging. • To do this, turn clockwise.
MiniPurge® Control Unit	the Minimum Pressure Sensor setting has drifted above the CLAPS setting	<p>The Minimum Pressure Sensor needs re-calibrating.</p> <ul style="list-style-type: none"> • Refer to Re-calibration of Pressure Sensors in the Maintenance section



Relief Valve opens (continuously or intermittently)

Fault Location	Cause	Solution
Pressurized Enclosure	Enclosure pressure is too high due to CLAPS Regulator being open too far.	Adjust the CLAPS Regulator.
Relief Valve Unit	Debris on the Relief Valve disk allowing air to leak from the valve.	Remove Relief Valve cover and clean the valve disk.

System enters purging but purge indication does not occur

Fault Location	Cause	Solution
Air Supply	Insufficient flow rate due to inadequate air supply pressure. Often due to pressure drop in the supply pipe.	Static pressure of 5 barg must be maintained during purge <ul style="list-style-type: none"> • Check air supply pressure at the inlet to the control unit. • Ensure that the supply pipe bore is suitable for the flow rate
Pressurized Enclosure	Excessive leakage from the pressurized enclosure.	<ul style="list-style-type: none"> • Check around the enclosure while purging is taking place. • Total leakage at purge outlet valve should not exceed 10% of purge flow sensor setting. • Check for leakage down cables and conduit.
Pipe Work	Tubing from Relief Valve flow sensing point not airtight.	<ul style="list-style-type: none"> • Ensure fitting nuts are tightened. • Check for tube damage. • Repair as necessary.
Relief Valve Unit	Relief Valve opening during purge.	<ul style="list-style-type: none"> • Check enclosure pressure on start up is less than Relief Valve lift off pressure.
MiniPurge Control Unit	Flow sensor setting incorrect.	<ul style="list-style-type: none"> • Check the pressure is correct on the flow sensor.

System begins purging but cycles fail to complete

Fault Location	Cause	Solution
Electronic Timer	Time set to 00	<ul style="list-style-type: none"> • Reset timer to correct purge time.
	The intrinsically safe battery pack is discharged	<ul style="list-style-type: none"> • Replace as necessary.

Flow restrictor ball valve opens/closes by itself

Fault Location	Cause	Solution
Electronic Timer	Flow restrictor locknut loose	<ul style="list-style-type: none"> • Tighten locknut to 2.5 N/m²
	Flow restrictor Shakeproof washer missing/damaged	<ul style="list-style-type: none"> • Replace washer - Expo part code S0019/028



Section 10: Recommended Spares List

Part Number	Description
KFL-AO1N-001	Filter Kit for S0015/275 filter / regulator
S0030/606	Purge flow sensor factory set to 6.4 mbarg
S0030/016	Minimum Pressure sensor, must be factory set to the value as stated on the Customer Test and Inspection Sheet
HSI-0160-000	Intermediate pressure sensor
S0030/588	CLAPS Sensor must be factory set to the value as stated on the Customer Test and Inspection Sheet
S0015/018	Pressure gauge (Air Supply Pressure), 0 - 10 barg
S0015/135	Miniature gauge (Logic Pressure), 0-4 barg
ETM-IS31-001	IS battery pack for electronic timer module
AGE-GE00-168	Electronic Timer Assembly c/w potted Timer Switch

Section 11: Glossary

Acronym	Definition
A&T	Alarm and Trip
AO	Alarm Only
CLAPS	Closed Loop Automatic Pressurization System
CU	Control Unit
ET	Electronic Timer
FCV	Flow Control Valve
IS	Intrinsically Safe
LC	Leakage Compensation
PA	Power and Alarm
RLV	Relief Valve Unit

Section 12: Drawings and Diagrams

Title	Drawing Number	Number of Sheets
D771 Control Unit - Electronic Timer	D771MOTORSYS-E	2
Motorpurge Hook-Up	MOTOR-HU	1
D758-3 P and I Diagram	D758-PI	1
D758 Circuit Diagram	AGM-PA00-021	1
D758 Ex e Terminal Box Layout	AGE-WC00154	1
Manual Override Switch Hook Up	AGE-WC00-117	1
Size 5 MOTORPURGE RLV	XBR-RTD0-009	1
MiniPurge® X LC Sequence Diagram	XBR-7TD0-040	1
System Status Indication	TP-518-058-WD	1



Section 13: FM ML384 Manual

Certificates can be found in the accompanying booklet ML497.

Component	Certificate	Number
Purge System	EU Declaration of Conformity	SC004 *
	UKCA Declaration of Conformity	SC004-UK *
	ATEX Certificate	SIRA 01ATEX1295X
	IECEX Certificate	IECEX SIR07.0027X
	UKCA Certificate	CSAE 21UKEX1067X
	INMETRO/TÜV Certificate	TÜV 12.1462X
	CCC Certificate	2020312304000830
	EAC Certificate	EAЭC RU C-GB.AЖ58.B.00906/20
MIU/e Ex e Terminal Box	EU Declaration of Conformity	SC027 *
	UKCA Declaration of Conformity	SC027-UK *
	ATEX Certificate	ExVeritas 19 ATEX0542X
	IECEX Certificate	IECEX EXV 19.0057X
	UKCA Certificate	ExVeritas 21UKEX1051X
	INMETRO/TÜV Certificate	TÜV 12.1463
	CCC Certificate	2020312303000422
Electronic Timer	EU Declaration of Conformity	SC039 *
	ATEX Certificate	FM 10 ATEX0003X
	IECEX Certificate	IECEX FME 10.0001X
Electronic Switches	ATEX Certificate	EPS 14 ATEX 1766 X
	IECEX Certificate	IECEX EPS 14.0092X
	CCC Certificate	2020322304000843
	EAC Certificate	TC RU C-DE.BH02.B.00222

* Documents are attached to the manual.

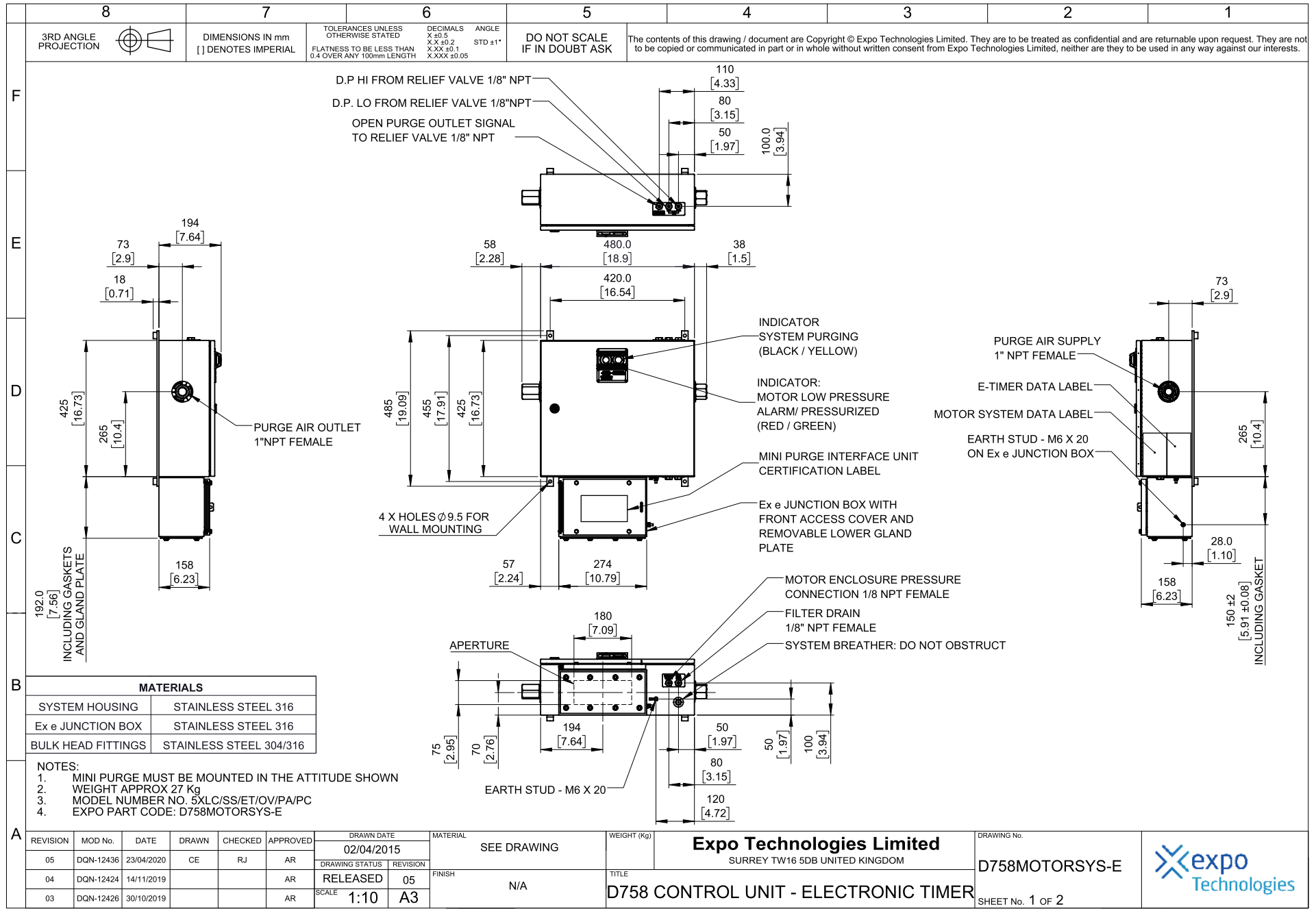

8	7	6	5	4	3	2	1																																																																										
3RD ANGLE PROJECTION	DIMENSIONS IN mm [] DENOTES IMPERIAL	TOLERANCES UNLESS OTHERWISE STATED FLATNESS TO BE LESS THAN 0.4 OVER ANY 100mm LENGTH	DECIMALS ANGLE X ±0.3 X.X ±0.2 X.XX ±0.1 X.XXX ±0.05	DO NOT SCALE IF IN DOUBT ASK	The contents of this drawing / document are Copyright © Expo Technologies Limited. They are to be treated as confidential and are returnable upon request. They are not to be copied or communicated in part or in whole without written consent from Expo Technologies Limited, neither are they to be used in any way against our interests.																																																																												
F	<p>SCRAP VIEW WITH DOOR FITTED TO SHOW INDICATORS</p>				<table border="1" style="width:100%; border-collapse: collapse;"> <thead> <tr> <th style="width:10%;">ITEM NO.</th> <th>PART DESCRIPTION</th> </tr> </thead> <tbody> <tr><td>1</td><td>PURGE OULET OPEN SIGNAL VALVE (1)</td></tr> <tr><td>2</td><td>PURGE COMPLETE BOOST VALVE</td></tr> <tr><td>3</td><td>SYSTEM PURGING SWITCH, 250V 4A, SPNO Ex d II (OPTIONAL)</td></tr> <tr><td>4</td><td>TIMER SWITCH</td></tr> <tr><td>5</td><td>CLAPS REGULATOR</td></tr> <tr><td>6</td><td>TIME SELECTOR SWITCHES</td></tr> <tr><td>7</td><td>PURGE FLOW RESTRICTOR</td></tr> <tr><td>8</td><td>PURGE VALVE</td></tr> <tr><td>9</td><td>ALARM / PRESSURIZED SWITCH, 250V 4A, SPNO Ex d II</td></tr> <tr><td>10</td><td>POWER INTERLOCK SWITCH, 250V 4A, DPNO Ex d II</td></tr> <tr><td>11</td><td>LOGIC MANIFOLD</td></tr> <tr><td>12</td><td>PURGE FLOW SENSOR</td></tr> <tr><td>13</td><td>PURGE COMPLETE VALVE</td></tr> <tr><td>14</td><td>TIMER VALVE</td></tr> <tr><td>15</td><td>MINIMUM PRESSURE SENSOR</td></tr> <tr><td>16</td><td>INTERMEDIATE PRESSURE SENSOR</td></tr> <tr><td>17</td><td>PURGE OULET OPEN SIGNAL VALVE (2)</td></tr> <tr><td>18</td><td>FLOW RESTRICTOR (CLAPS SENSOR)</td></tr> <tr><td>19</td><td>CLAPS SENSOR</td></tr> <tr><td>20</td><td>AIR SUPPLY FILTER / REGULATOR</td></tr> <tr><td>21</td><td>GAUGE - MAIN AIR SUPPLY</td></tr> <tr><td>22</td><td>GAUGE - LOGIC AIR SUPPLY</td></tr> <tr><td>23</td><td>REGULATOR - LOGIC AIR SUPPLY</td></tr> <tr><td>24</td><td>INTERMEDIATE SWITCH ACTUATOR</td></tr> <tr><td>25</td><td>INTERMEDIATE SWITCH, 250V 4A, SPNO Ex d II</td></tr> <tr><td>26</td><td>ELECTRONIC PURGE TIMER</td></tr> <tr><td>27</td><td>I.S BATTERY PACK</td></tr> <tr><td>28</td><td>INDICATOR ALARM / PRESSURIZED</td></tr> <tr><td>29</td><td>INDICATOR - SYSTEM PURGING</td></tr> <tr><td>30</td><td>MINI PURGE DOUBLE INDICATOR LABEL</td></tr> <tr><td>31</td><td>MINI PURGE CERTIFICATION LABEL (FITTED INSIDE DOOR)</td></tr> <tr><td>32</td><td>TERMINAL RAIL</td></tr> <tr><td>33</td><td>TERMINALS Ex COMPLIANT</td></tr> <tr><td>34</td><td>/PA TERMINAL BOX</td></tr> <tr><td>35</td><td>ELECTRONIC TIMER LABEL</td></tr> <tr><td>36</td><td>STAINLESS STEEL DOUBLE VISIWINK PROTECTOR</td></tr> </tbody> </table>			ITEM NO.	PART DESCRIPTION	1	PURGE OULET OPEN SIGNAL VALVE (1)	2	PURGE COMPLETE BOOST VALVE	3	SYSTEM PURGING SWITCH, 250V 4A, SPNO Ex d II (OPTIONAL)	4	TIMER SWITCH	5	CLAPS REGULATOR	6	TIME SELECTOR SWITCHES	7	PURGE FLOW RESTRICTOR	8	PURGE VALVE	9	ALARM / PRESSURIZED SWITCH, 250V 4A, SPNO Ex d II	10	POWER INTERLOCK SWITCH, 250V 4A, DPNO Ex d II	11	LOGIC MANIFOLD	12	PURGE FLOW SENSOR	13	PURGE COMPLETE VALVE	14	TIMER VALVE	15	MINIMUM PRESSURE SENSOR	16	INTERMEDIATE PRESSURE SENSOR	17	PURGE OULET OPEN SIGNAL VALVE (2)	18	FLOW RESTRICTOR (CLAPS SENSOR)	19	CLAPS SENSOR	20	AIR SUPPLY FILTER / REGULATOR	21	GAUGE - MAIN AIR SUPPLY	22	GAUGE - LOGIC AIR SUPPLY	23	REGULATOR - LOGIC AIR SUPPLY	24	INTERMEDIATE SWITCH ACTUATOR	25	INTERMEDIATE SWITCH, 250V 4A, SPNO Ex d II	26	ELECTRONIC PURGE TIMER	27	I.S BATTERY PACK	28	INDICATOR ALARM / PRESSURIZED	29	INDICATOR - SYSTEM PURGING	30	MINI PURGE DOUBLE INDICATOR LABEL	31	MINI PURGE CERTIFICATION LABEL (FITTED INSIDE DOOR)	32	TERMINAL RAIL	33	TERMINALS Ex COMPLIANT	34	/PA TERMINAL BOX	35	ELECTRONIC TIMER LABEL	36	STAINLESS STEEL DOUBLE VISIWINK PROTECTOR
ITEM NO.	PART DESCRIPTION																																																																																
1	PURGE OULET OPEN SIGNAL VALVE (1)																																																																																
2	PURGE COMPLETE BOOST VALVE																																																																																
3	SYSTEM PURGING SWITCH, 250V 4A, SPNO Ex d II (OPTIONAL)																																																																																
4	TIMER SWITCH																																																																																
5	CLAPS REGULATOR																																																																																
6	TIME SELECTOR SWITCHES																																																																																
7	PURGE FLOW RESTRICTOR																																																																																
8	PURGE VALVE																																																																																
9	ALARM / PRESSURIZED SWITCH, 250V 4A, SPNO Ex d II																																																																																
10	POWER INTERLOCK SWITCH, 250V 4A, DPNO Ex d II																																																																																
11	LOGIC MANIFOLD																																																																																
12	PURGE FLOW SENSOR																																																																																
13	PURGE COMPLETE VALVE																																																																																
14	TIMER VALVE																																																																																
15	MINIMUM PRESSURE SENSOR																																																																																
16	INTERMEDIATE PRESSURE SENSOR																																																																																
17	PURGE OULET OPEN SIGNAL VALVE (2)																																																																																
18	FLOW RESTRICTOR (CLAPS SENSOR)																																																																																
19	CLAPS SENSOR																																																																																
20	AIR SUPPLY FILTER / REGULATOR																																																																																
21	GAUGE - MAIN AIR SUPPLY																																																																																
22	GAUGE - LOGIC AIR SUPPLY																																																																																
23	REGULATOR - LOGIC AIR SUPPLY																																																																																
24	INTERMEDIATE SWITCH ACTUATOR																																																																																
25	INTERMEDIATE SWITCH, 250V 4A, SPNO Ex d II																																																																																
26	ELECTRONIC PURGE TIMER																																																																																
27	I.S BATTERY PACK																																																																																
28	INDICATOR ALARM / PRESSURIZED																																																																																
29	INDICATOR - SYSTEM PURGING																																																																																
30	MINI PURGE DOUBLE INDICATOR LABEL																																																																																
31	MINI PURGE CERTIFICATION LABEL (FITTED INSIDE DOOR)																																																																																
32	TERMINAL RAIL																																																																																
33	TERMINALS Ex COMPLIANT																																																																																
34	/PA TERMINAL BOX																																																																																
35	ELECTRONIC TIMER LABEL																																																																																
36	STAINLESS STEEL DOUBLE VISIWINK PROTECTOR																																																																																
E	<p>SCRAP VIEW OF DOOR FROM INSIDE</p>																																																																																
D	<p>FRONT VIEW WITH DOORS REMOVED TO SHOW INTERNAL LAYOUTS OF CONTROL UNIT AND Ex e JUNCTION BOX</p>																																																																																
C	<p>SCRAP VIEW OF DOOR FROM INSIDE</p>																																																																																
B																																																																																	
A																																																																																	

REVISION	MOD No.	DATE	DRAWN	CHECKED	APPROVED	DRAWN DATE	MATERIAL	WEIGHT (Kg)	DRAWING No.
05	DQN-12436	23/04/2020	CE	RJ	AR	02/04/2015	SEE DRAWING		D758MOTORSYS-E
04	DQN-12424	14/11/2019			AR	RELEASED			
03	DQN-12426	30/10/2019			AR	SCALE 1:10	N/A		

Expo Technologies Limited SURREY TW16 5DB UNITED KINGDOM	TITLE D758 CONTROL UNIT - ELECTRONIC TIMER	SHEET No. 2 OF 2	
--	--	------------------	--

8	7	6	5	4	3	2	1
3RD ANGLE PROJECTION	DIMENSIONS IN mm [] DENOTES IMPERIAL	TOLERANCES UNLESS OTHERWISE STATED FLATNESS TO BE LESS THAN 0.4 OVER ANY 100mm LENGTH	DECIMALS X.X ±0.5 X.XX ±0.2 X.XXX ±0.1 X.XXXX ±0.05	ANGLE STD ±1°	DO NOT SCALE IF IN DOUBT ASK	The contents of this drawing / document are Copyright © Expo Technologies Limited. They are to be treated as confidential and are returnable upon request. They are not to be copied or communicated in part or in whole without written consent from Expo Technologies Limited, neither are they to be used in any way against our interests.	

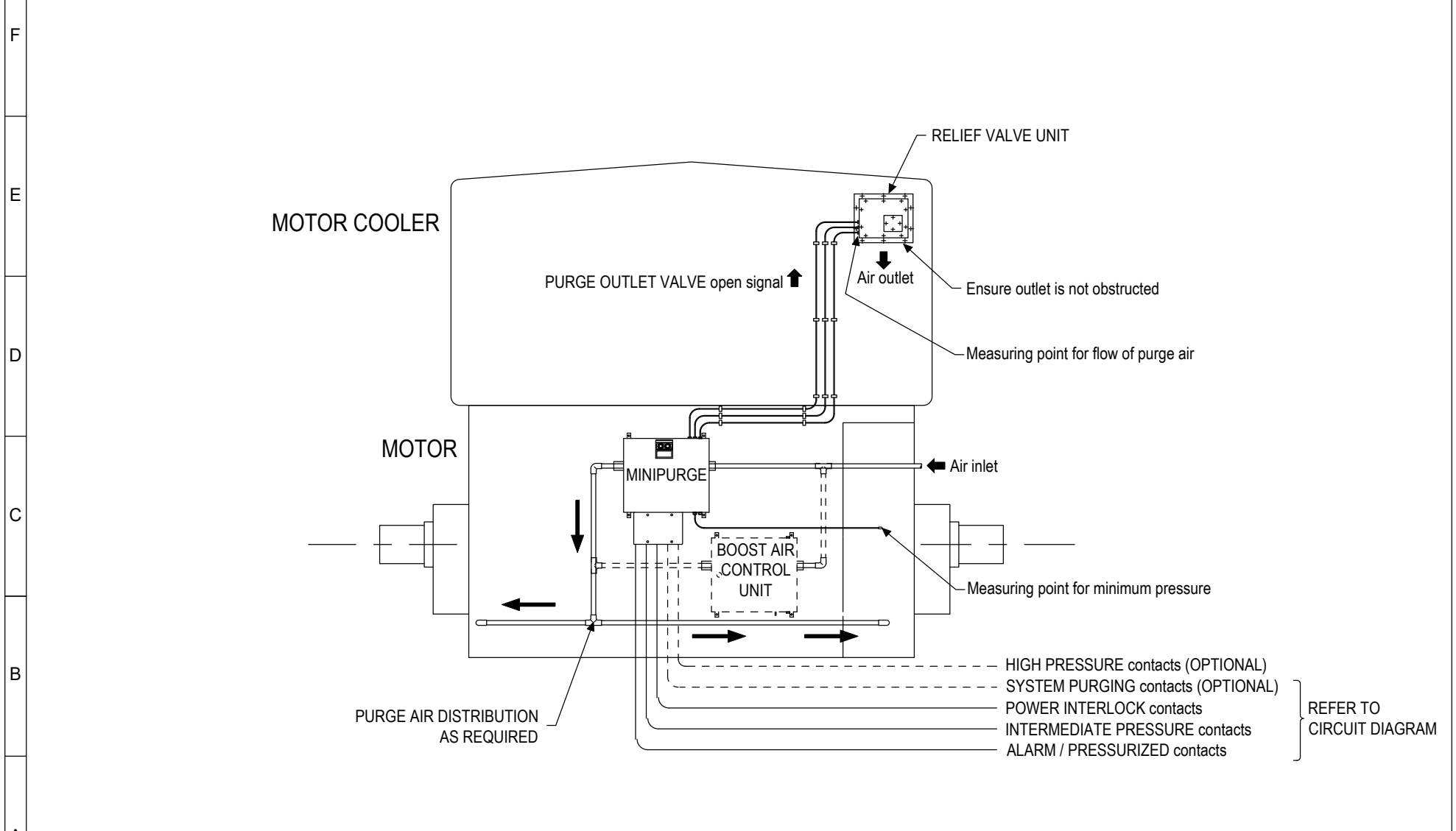

A	REVISION	MOD #	DATE	DRAWN	CHECKED	APPROVED	DRAWN DATE	MATERIAL	WEIGHT (Kg)	Expo Technologies Limited SURREY TW16 5DB UNITED KINGDOM	DRAWING No.	
	03	03	27/04/20	CE	AR	MH	03/07/2019				MOTOR-HU	
	02	02	19/02/20			MH	CERT REL	03	FINISH	TITLE	SHEET No. 1 OF 1	
	01	01	03/07/19	LG	MLC	MLC	SCALE	N.T.S	A3	MOTORPURGE HOOK UP		

8	7	6	5	4	3	2	1
3RD ANGLE PROJECTION	DIMENSIONS IN mm [] DENOTES IMPERIAL	TOLERANCES UNLESS OTHERWISE STATED FLATNESS TO BE LESS THAN 0.4 OVER ANY 100mm LENGTH	DECIMALS X ±0.5 X X ±0.2 X.XX ±0.1 X.XXX ±0.05	ANGLE STD ±1°	DO NOT SCALE IF IN DOUBT ASK	The contents of this drawing / document are Copyright © Expo Technologies Limited. They are to be treated as confidential and are returnable upon request. They are not to be copied or communicated in part or in whole without written consent from Expo Technologies Limited, neither are they to be used in any way against our interests.	

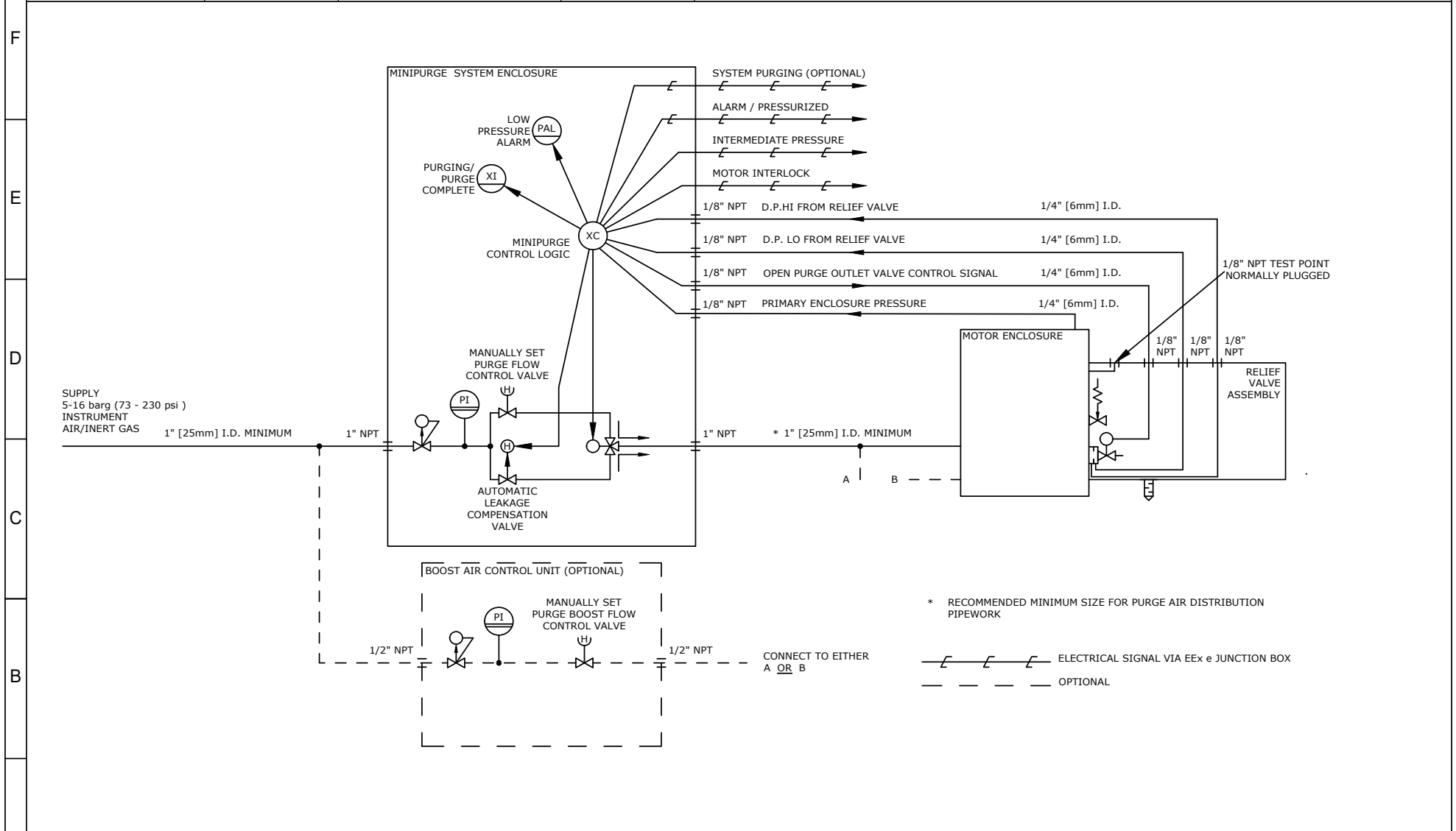

REVISION	MOD #	DATE	DRAWN	CHECKED	APPROVED	DRAWN DATE	MATERIAL	WEIGHT (kg)	Expo Technologies Limited SURREY TW16 5DB UNITED KINGDOM	DRAWING No.	
11	DQN-12436	28/04/20	CE	AR	MH	10/01/2008				D758-PI	
10	DQN-12429	15/01/20			AW	CERT REL 11	FINISH	TITLE		SHEET No. 1 OF 1	
09	5402	18/11/11			JPdB	SCALE N.T.S A3		D758 P AND I DIAGRAM			

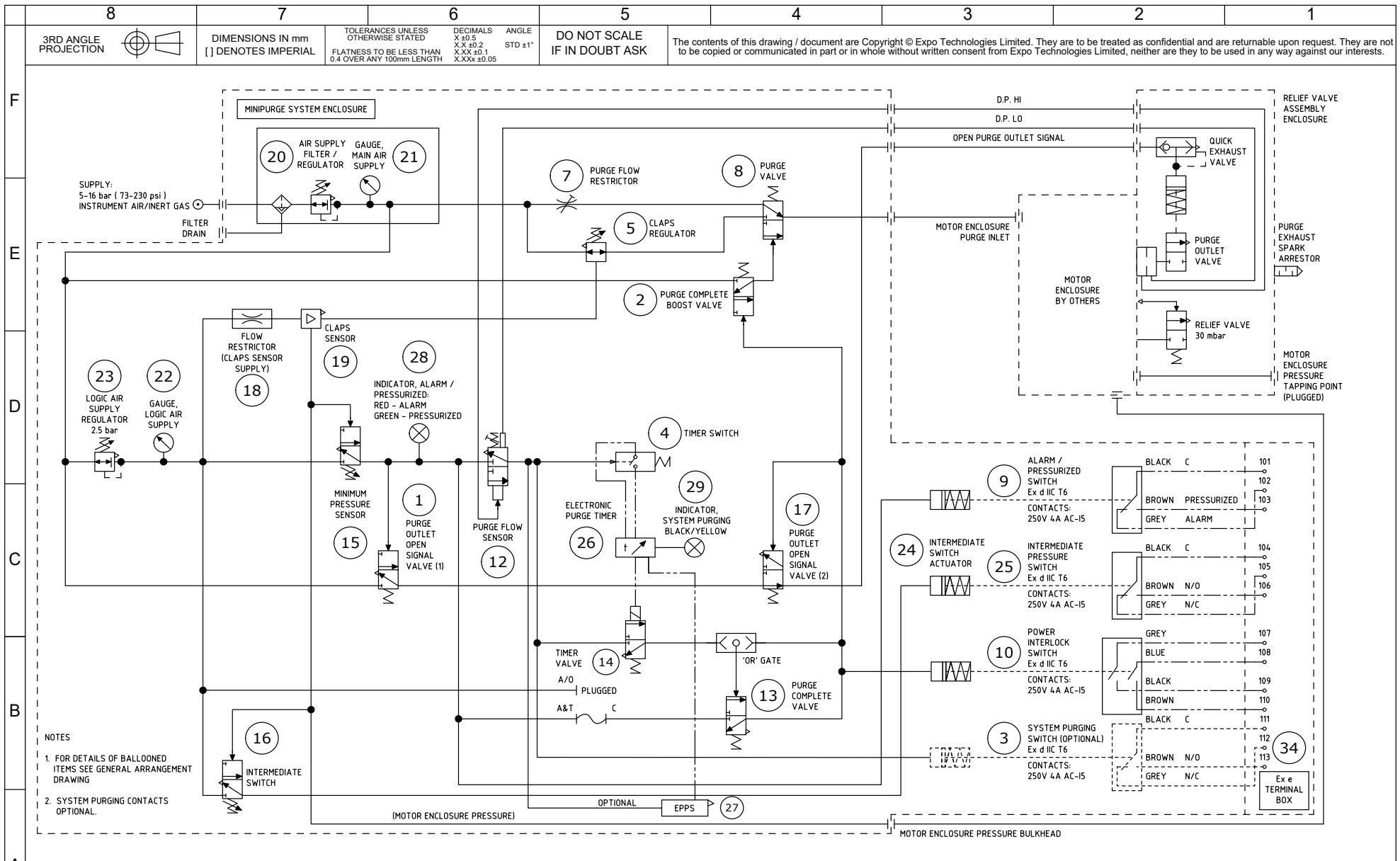

NOTES

- FOR DETAILS OF BALLOONED ITEMS SEE GENERAL ARRANGEMENT DRAWING
- SYSTEM PURGING CONTACTS OPTIONAL.

REVISION						DRAWN DATE		MATERIAL	WEIGHT (Kg)	Expo Technologies Limited SURREY TW16 5DB UNITED KINGDOM	DRAWING No.	AGM-PA00-021	SHEET No. 1 OF 1
REVISION	MOD #	DATE	DRAWN	CHECKED	APPROVED	DATE	REVISION						
13	DQN-12436	27/04/20	CE	AR	MH	23/10/2007							
12	6736	10/04/19			MLC	CERT REL	13						
11	DQN-12412	23/03/18			MLC	SCALE	N.T.S	A3					

D758 CIRCUIT DIAGRAM



8	7	6	5	4	3	2	1
3RD ANGLE PROJECTION	DIMENSIONS IN mm [] DENOTES IMPERIAL	TOLERANCES UNLESS OTHERWISE STATED FLATNESS TO BE LESS THAN 0.4 OVER ANY 100mm LENGTH	DECIMALS X ±0.3 XX ±0.2 XXX ±0.1 X.XXX ±0.05	ANGLE STD ±1°	DO NOT SCALE IF IN DOUBT ASK	The contents of this drawing / document are Copyright © Expo Technologies Limited. They are to be treated as confidential and are returnable upon request. They are not to be copied or communicated in part or in whole without written consent from Expo Technologies Limited, neither are they to be used in any way against our interests.	

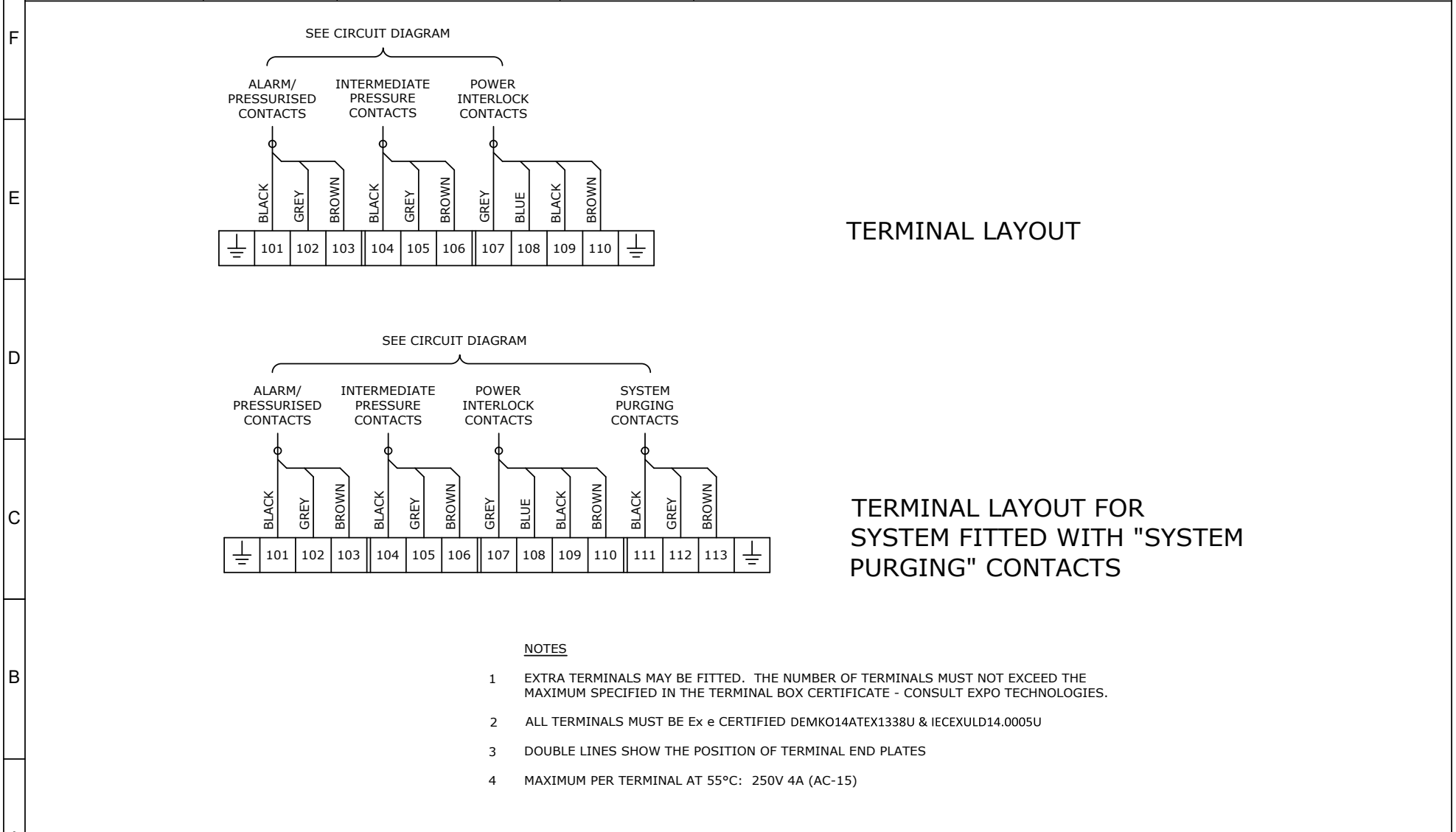

NOTES

- 1 EXTRA TERMINALS MAY BE FITTED. THE NUMBER OF TERMINALS MUST NOT EXCEED THE MAXIMUM SPECIFIED IN THE TERMINAL BOX CERTIFICATE - CONSULT EXPO TECHNOLOGIES.
- 2 ALL TERMINALS MUST BE Ex e CERTIFIED DEMKO14ATEX1338U & IECEXULD14.0005U
- 3 DOUBLE LINES SHOW THE POSITION OF TERMINAL END PLATES
- 4 MAXIMUM PER TERMINAL AT 55°C: 250V 4A (AC-15)

REVISION	MOD #	DATE	DRAWN	CHECKED	APPROVED	DRAWN DATE	MATERIAL	WEIGHT (Kg)	Expo Technologies Limited SURREY TW16 5DB UNITED KINGDOM	DRAWING No.
09	DQN-12436	28/04/20	CE	AR	MH	02/11/2007				AGE-WC00-154
08	6728	19/03/19			MH	CERT REL 09	FINISH	TITLE	D758 Ex e TERMINAL BOX LAYOUT	
07	5402	18/11/11			JPdB	SCALE N.T.S A3			SHEET No. 1 OF 1	



8	7	6	5	4	3	2	1
3RD ANGLE PROJECTION	DIMENSIONS IN mm [] DENOTES IMPERIAL	TOLERANCES UNLESS OTHERWISE STATED FLATNESS TO BE LESS THAN 0.4 OVER ANY 100mm LENGTH	DECIMALS X ±0.5 X.X ±0.2 X.XX ±0.1 X.XXX ±0.05	ANGLE STD ±1°	DO NOT SCALE IF IN DOUBT ASK	The contents of this drawing / document are Copyright © Expo Technologies Limited. They are to be treated as confidential and are returnable upon request. They are not to be copied or communicated in part or in whole without written consent from Expo Technologies Limited, neither are they to be used in any way against our interests.	

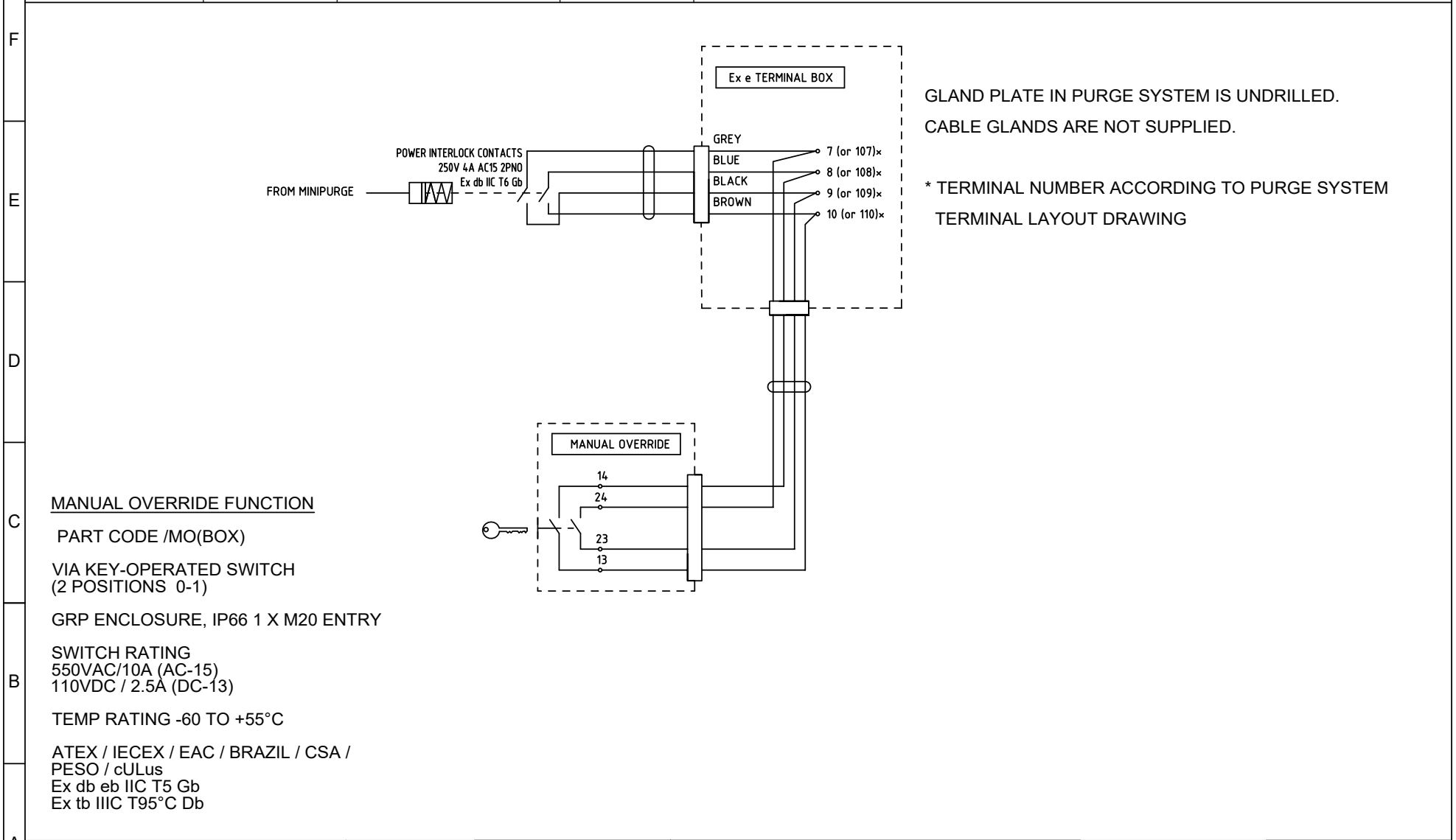

MANUAL OVERRIDE FUNCTION
 PART CODE /MO(BOX)
 VIA KEY-OPERATED SWITCH
 (2 POSITIONS 0-1)
 GRP ENCLOSURE, IP66 1 X M20 ENTRY
 SWITCH RATING
 550VAC/10A (AC-15)
 110VDC / 2.5A (DC-13)
 TEMP RATING -60 TO +55°C
 ATEX / IECEX / EAC / BRAZIL / CSA /
 PESO / cULus
 Ex db eb IIC T5 Gb
 Ex tb IIIC T95°C Db

REVISION	MOD #	DATE	DRAWN	CHECKED	APPROVED	DRAWN DATE	MATERIAL	WEIGHT (Kg)	Expo Technologies Limited SURREY TW16 5DB UNITED KINGDOM	DRAWING No.	
13	DQN-12472	01/04/21	AR	CE	AW	01/07/2013				AGE-WC00-117	
12	DQN-12446	20/07/20	AR	CE	AW	CERT REL	13	FINISH	TITLE		
11	DQN-12429	05/05/20	AR	CE	MH	SCALE	N.T.S	A3	MANUAL OVERRIDE SWITCH HOOK-UP	SHEET No. 1 OF 1	

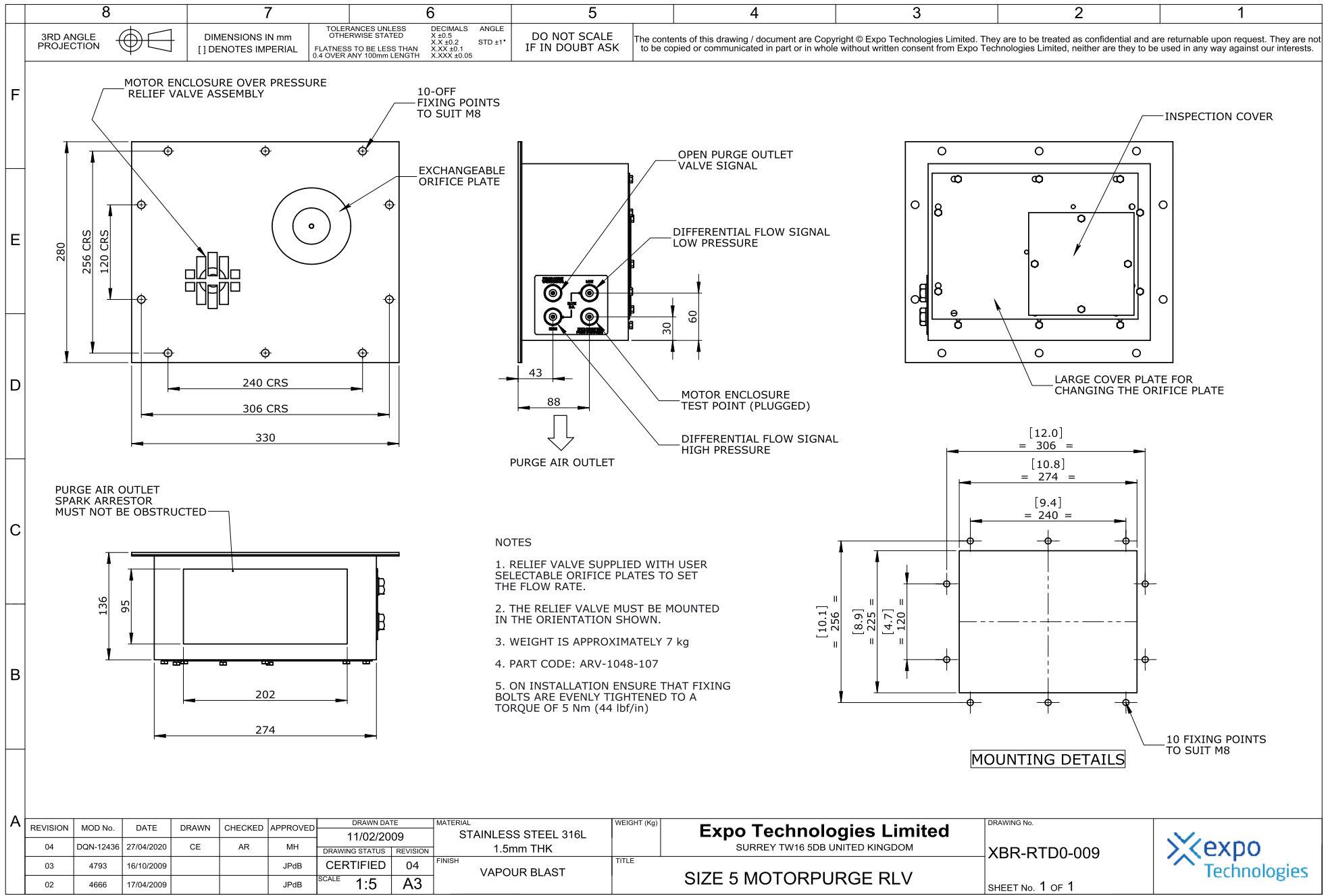

8 7 6 5 4 3 2 1

3RD ANGLE PROJECTION  DIMENSIONS IN mm [] DENOTES IMPERIAL TOLERANCES UNLESS OTHERWISE STATED DECIMALS X ±0.5 ANGLE STD ±1° FLATNESS TO BE LESS THAN 0.4 OVER ANY 100mm LENGTH X.X ±0.2 X.XX ±0.1 X.XXX ±0.05 DO NOT SCALE IF IN DOUBT ASK The contents of this drawing / document are Copyright © Expo Technologies Limited. They are to be treated as confidential and are returnable upon request. They are not to be copied or communicated in part or in whole without written consent from Expo Technologies Limited, neither are they to be used in any way against our interests.

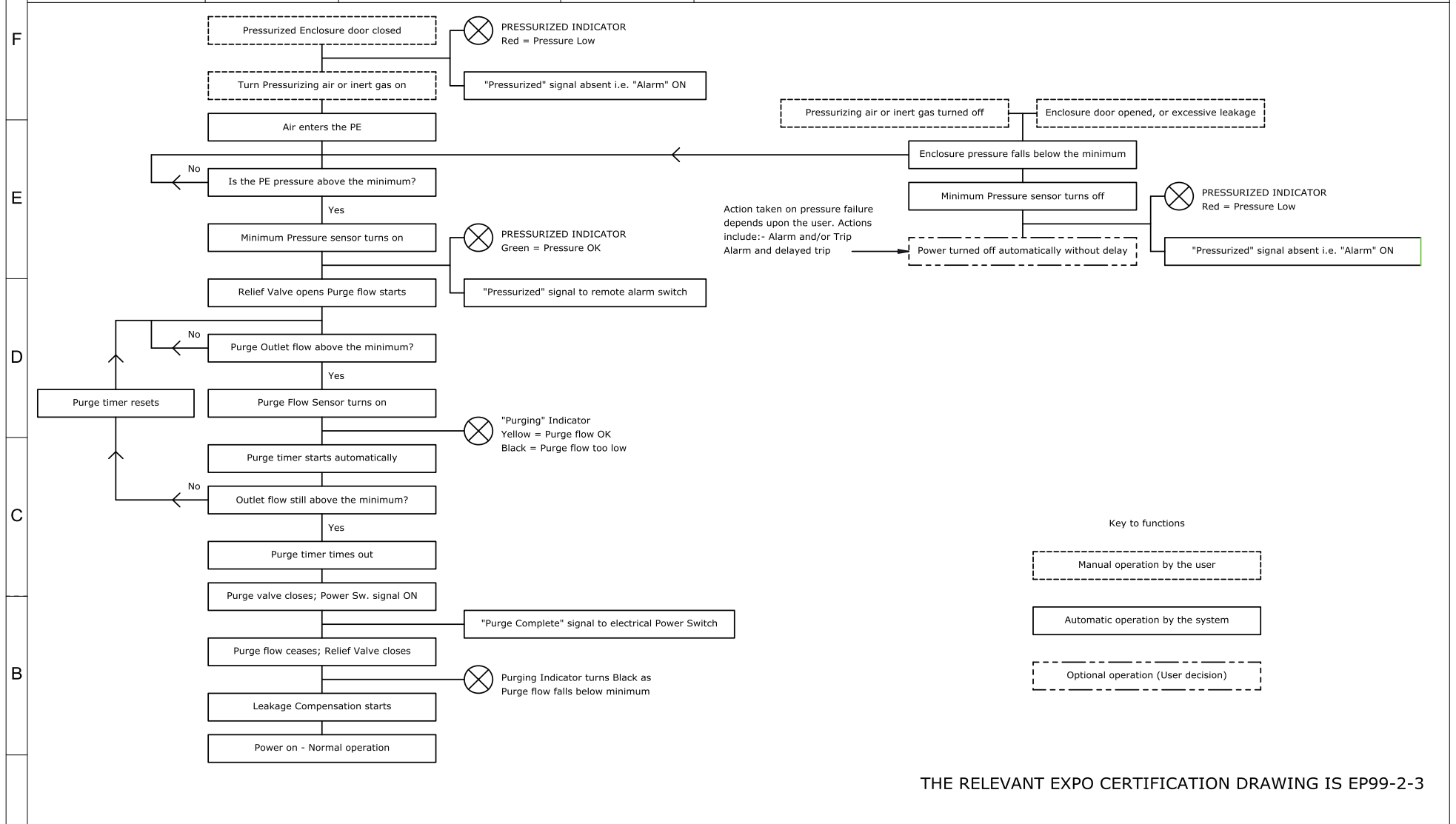

THE RELEVANT EXPO CERTIFICATION DRAWING IS EP99-2-3

REVISION	MOD No.	DATE	DRAWN	CHECKED	APPROVED	DRAWN DATE	MATERIAL	WEIGHT (Kg)	Expo Technologies Limited		DRAWING No.
03	DQN-12436	28/04/2020	AW	AR	MH	23/06/2010			SURREY TW16 5DB UNITED KINGDOM		XBR-7TD0-040
02	5434	20/12/2011			JPdB	CERTIFIED	03		FINISH		
01	DRAWN	23/06/2010			JPdB	SCALE 1:1	A3		TITLE		SHEET No. 1 OF 1





MiniPurge Interface Unit MIU/e User Instruction Manual

Manufacturer: **Expo Technologies Ltd**, Unit 2 The Summit, Sunbury on Thames. UK.

Model Type & Rating:

MIU/e1	MIU/e2	MIU/e1/MO
400V / 7A	400V / 7A	400 V / 2A

Certificates:

Hazardous Area Marking Code:

IECEX EXV 19.0057X	ExVeritas 19 ATEX 0542X	TUV 12.1463
Ex eb IIC T5 Gb Ex tb IIIC T100°C Db Tamb -20°C to +55°C	Ex II 2 G Ex eb IIC T5 Gb Ex II 2 D Ex tb IIIC T100°C Db Tamb -20°C to +55°C	Ex e IIC T5 Gb Ex tb IIIC T100° Db IP66 Tamb -20°C to +55°C
Ex eb IIC T4 Gb Tamb -20°C to +60°C	Ex II 2 G Ex eb IIC T4 Gb Tamb -20°C to +60°C	Ex e IIC T4 Gb Tamb -20°C to +60°C

APPLICATION SUITABILITY

The MiniPurge Interface Units – MIU/e are certified for use in Hazardous Areas where the Hazardous Area is non-mining (i.e. above ground) and the hazard is caused by flammable gasses or vapours. The systems may be used in ATEX/IECEX Gas Zones 1 & 2, Gas Groups IIA, IIB & IIC and in Dust Zones 21 & 22, Dust Groups IIIA, IIIB & IIIC.

The following materials are used in the construction of MIU/e: Stainless Steel, Steel, Brass, Copper, Polyamide, Silicone. If substances that will adversely affect any of these materials are present in the surrounding environment, please consult Expo Technologies for further guidance. This equipment is designed for use under normal industrial conditions of ambient temperature, humidity and vibration. Please consult Expo Technologies before installing this equipment in conditions that may cause stresses beyond normal industrial conditions.

WARNING - Only install, commission, inspect, maintain or fault find when safe to do so.

INSTALLATION

The MIU/e shall be installed in accordance with relevant standards, such as IEC 60079-14 and any local codes of practice that are in force.

The MIU/e shall be connected to the Purge and Pressurization system in accordance with the instructions given in the handbook supplied with the pressurization system.

The external earth connection of the MIU/e shall be connected to earth using minimum 4mm² conductor.

SELECTION OF CABLE, CABLE GLANDS AND CONDUCTORS IN CONDUIT

Cable glands or other cable entry devices shall be appropriately certified and suitable for the cable and the conditions of use and be installed in accordance with the manufacturer's instructions.

When the MIU/e application requires the hazardous area marking code:

Ex eb IIC T5 Gb, Tamb -20°C to +55°C there is no further guidance for the selection of cable and cable glands or conductors in conduit.

When the MIU/e application requires the hazardous area marking code:

Ex eb IIC T4 Gb, Tamb -20°C to +60°C the user shall select cable and cable glands or conductors in conduit that have a higher temperature rating than 83.2°C.

TERMINALS

MIU/e may be fitted with a combination of:

WDU2.5 terminals certified to DEMKO 14 ATEX 1338U & IECEX ULD 14.0005U.

SAK2.5 terminals certified to KEMA 97 ATEX 1798U & IECEX KEM06.0014U.

WPE2.5 Earth terminals certified to DEMKO 14 ATEX 1338U & IECEX ULD 14.0005U.

For all type of terminals:

Tightening torque range: 0.4 to 0.8 Nm (WDU & WPE) & 0.4 to 0.6 Nm (SAK).

Conductor cross section maximum 2.5 mm², minimum 1.5 mm².

Type of connection is screwed - Solid copper conductors to be used.

Stripping length shall be 10 mm.

Only one conductor is allowed at each side of a terminal. Multiple conductors shall be crimped together before screwed into the terminal.

Maximum number of terminals:

For Model MIU/e1 – Up to 18 current carrying terminals.

For Model MIU/e2 – Up to 33 current carrying terminals.

For Model MIU/e1/MO – Up to 13 current carrying terminals.

COMMISSIONING

The installation of the cable glands, electrical and earth connections shall be inspected for correct installation before the unit is put into service. The lid shall be correctly fitted.

MAINTENANCE

The condition of enclosure and associated cable glands shall be inspected for damage every six months. The terminals shall be inspected for tightness and gaskets inspected for damage.

FAULT FINDING

When wiring or signal fault occurs, check each terminated wire, terminals for tightness and gaskets for damage.

External faults such as broken switches within the Control Unit may also require investigation.



EU Authorised Representative:
ExpoPharma Engineering Services Ltd
46 Eastcote Drive, Little Island,
Co. Cork, T45 W/R68, Ireland.
E EUAR@expopharma.ie

Manufacturer:
Expo Technologies Ltd
Unit 2, The Summit, Hanworth Road,
Sunbury-on-Thames, TW16 5DB, U.K.
E sales@expoworldwide.com

EU Declaration of Conformity



This is to declare that the products listed below are manufactured in conformity with the following EU Directives under the sole authority of Expo Technologies Ltd:

Electromagnetic Compatibility Directive 2014/30/EU

MiniPurge Systems with a /PO suffix in the type number are non-electrical and are outside the scope of the EMC Directive. MiniPurge Systems with suffices /PA or /IS incorporate one or more volt-free ("dry") contacts which work in circuits specified by others. In normal operation these circuits are "benign" and no CE mark is appropriate. MiniPurge Systems with Electronic Timer (Option /ET and /ES) are designed to conform to the EMC Directive, in compliance with EN 61000-6-4:2007 and EN 61000-6-2:2005 (Intertek Report EM10048000) and 61000-6-4:2007 + A1:2011 and EN 61000-6-2:2005 (Intertek Report 102569070LHD-001) respectively.

Low Voltage Directive 2014/35/EU

MiniPurge Systems are intended for use in potentially explosive atmospheres (Hazardous Areas) and are therefore excluded from the Low Voltage Directive.

Pressure Equipment Directive 2014/68/EU

MiniPurge Systems are classified as not higher than category I under Article 13 of this Directive and intended for use in potentially explosive atmospheres (Hazardous Areas) and are therefore excluded from the Pressure Equipment Directive. MiniPurge Systems are covered under ATEX Directive 2014/34/EU.

ATEX Directive 2014/34/EU

MiniPurge Systems are designed to conform to the above Directive in fulfilment of the Essential Health & Safety requirements of Annexe II and in compliance with:

EN IEC 60079-0:2018 EN 60079-2:2014 EN 60079-11:2012

MiniPurge Systems are certified under EU Type-Examination Certificate Sira 01ATEX1295X by CSA Group (Netherlands) B.V., in compliance with:

EN 60079-0:2012 + A11:2013 EN 60079-2:2014 EN 60079-11:2012

MiniPurge Systems are manufactured under Production Quality Assurance Notification SIRA S9ATEXM043, issued by CSA Group (Netherlands) B.V. (EU Notified Body No. 2813).

Technical documentation and assessments are in the Expo Technologies confidential technical file SC004.

For and on behalf of Expo Technologies Ltd

John Paul De Beer
Managing Director

Date 23rd November 2021

SC004 EU DoC MiniPurge Systems Iss. 16



Manufacturer:
Expo Technologies Ltd
Unit 2, The Summit, Hanworth Road,
Sunbury-on-Thames, TW16 5DB, U.K.
E sales@expoworldwide.com

UK Declaration of Conformity



This is to declare that the products listed below are manufactured in conformity with the following UK Product Regulations under the sole authority of Expo Technologies Ltd

MiniPurge® Purge & Pressurization Systems

A range of systems intended to provide explosion protection of electrical enclosures through purge & pressurization under international and national standards.

Electromagnetic Compatibility Regulations 2016 (SI 2016/1091)

MiniPurge Systems with a /PO suffix in the type number are non-electrical and are outside the scope of the EMC Regulations.

MiniPurge Systems with suffices /PA or /IS incorporate one or more volt-free ("dry") contacts which work in circuits specified by others. In normal operation these circuits are "benign" and no UKCA mark is appropriate.

MiniPurge Systems with Electronic Timer (Option /ET and /ES) are designed to conform to the EMC Regulations, in compliance with EN 61000-6-4:2007 and EN 61000-6-2:2005 (Intertek Report EM10048000) and 61000-6-4:2007 + A1:2011 and EN 61000-6-2:2005 (Intertek Report 102569070LHD-001) respectively.

Electrical Equipment (Safety) Regulations 2016 (SI 2016/1101)

MiniPurge Systems are intended to be used in potentially explosive areas (hazardous areas) and are therefore excluded from the Regulation.

Pressure Equipment (Safety) Regulations 2016 (SI 2016/1105)

MiniPurge Systems are classified as not higher than Category I under article 13 of this Regulation and also intended for use in potentially explosive atmospheres and are therefore excluded from this Regulation.

Equipment and Protective Systems intended for use in Potentially Explosive Atmospheres Regulations, UKSI 2016:1107 (as amended) - Schedule 3A Part 1

MiniPurge Systems are designed to conform to the above Regulations in fulfilment of the Essential Health & Safety requirements of Annexe II and in compliance with:

EN IEC 60079-0:2018 EN 60079-2:2014 EN 60079-11:2012

MiniPurge Systems are certified under UK Type-Examination Certificate CSAE 21 UKEX 1067X by CSA Group Testing UK Ltd. (UK Conformity Assessment Body No. 0518) in compliance with:

EN 60079-0:2012 + A11:2013 EN 60079-2:2014 EN 60079-11:2012

MiniPurge Systems are manufactured under Production Quality Assurance Notification CSAE 21 UKQAN 0005, issued by CSA Group Testing UK Ltd. (UK Conformity Assessment Body No. 0518).

Technical documentation and assessments are in the Expo Technologies confidential technical file SC004.

For and on behalf of Expo Technologies Ltd

John Paul De Beer
Managing Director

Date 15th December 2021

SC004-UK.v1 UKCA DoC MiniPurge Iss. 1



EU Authorised Representative:
ExpoPharma Engineering Services Ltd
46 Eastcote Drive, Little Island,
Co. Cork, T45 W/R68, Ireland.
E EUAR@expopharma.ie

Manufacturer:
Expo Technologies Ltd
Unit 2, The Summit, Hanworth Road,
Sunbury-on-Thames, TW16 5DB, U.K.
E sales@expoworldwide.com

EU Declaration of Conformity

This is to declare that the products listed below are manufactured in conformity with the following EU Directives under the sole authority of Expo Technologies Ltd:

Expo Technologies MiniPurge Interface Units Type MIU/e1, MIU/e2 and MIU/e1-MO

Electromagnetic Compatibility Directive 2014/30/EU

Clause 1.1.3 Equipment covered by other specific Community Directives: Compliance with the Essential Health and Safety Requirements has been assured to conform to the following list of Standards:

EN IEC 60079-0:2018

EN 60079-7:2015

EN 60079-31:2014

Clause 1.1.4 Inherently benign equipment: the electrical equipment associated with the MIU/e are Ex d switch(es) certified under EPS 14ATEX1766X and used within the MiniPurge Control system. These switches are terminated inside the MIU/e at Ex e terminal(s) certified under DEMKO 14ATEX1388U and are not capable of generating or contributing to electromagnetic emission. These switches are capable of operating without degradation in the presence of electromagnetic disturbance in their intended environment.

Low Voltage Directive 2014/35/EU

MiniPurge Interface Units MIU/e are intended for use in potentially explosive atmospheres (Hazardous Areas) and are therefore excluded from the Low Voltage Directive. Electrical safety conforms to EN 61010:2010

Pressure Equipment Directive 2014/68/EU

MiniPurge Interface Units MIU/e are classified as not higher than category I under Article 13 of this Directive and intended for use in potentially explosive atmospheres (Hazardous Areas) and are therefore excluded from the Pressure Equipment Directive.

ATEX Directive 2014/34/EU

MiniPurge Interface Units MIU/e are designed to conform to the ATEX Directive in fulfilment of the Essential Health & Safety requirements of Annexe II, in compliance with:

EN IEC 60079-0:2018

EN 60079-7:2015+A1:2018

EN 60079-31: 2014.

MiniPurge Interface Units MIU/e are certified by ExVeritas, Units 16-18, Abenbury Way, Wrexham Industrial Estate, Wrexham, United Kingdom, LL13 9UZ, under EU Type Certification ExVeritas 19ATEX0542X in compliance with:

EN IEC 60079-0:2018

EN 60079-7:2015+A1:2018

EN 60079-31: 2014.

MiniPurge Interface Units MIU/e are manufactured under Production QAN Sira 99ATEXM043, issued by CSA Group (Netherlands) B.V. (EU Notified Body No. 2813).

Technical documentation and assessments are in the Expo Technologies confidential technical file SC027.

For and on behalf of Expo Technologies Ltd

John Paul De Beer
Managing Director

Date 2nd November 2021

SC027-CE.v9 MIU/e EU DoC



Manufacturer:
Expo Technologies Ltd
Unit 2, The Summit, Hanworth Road,
Sunbury-on-Thames, TW16 5DB, U.K.
E sales@expoworldwide.com

UK Declaration of Conformity



This is to declare that the products listed below are manufactured in conformity with the following UK Product Regulations under the sole authority of Expo Technologies Ltd

Expo Technologies MiniPurge Interface Units Type MIU/e1, MIU/e2 and MIU/e1-MO

Electromagnetic Compatibility Regulations 2016 (SI 2016/1091)

Clause 1.1.3 Equipment covered by other specific Regulations: Compliance with the Essential Health and Safety Requirements has been assured to conform to the following list of Standards:

EN IEC 60079-0:2018 EN 60079-7:2015 EN 60079-31:2014

Clause 1.1.4 Inherently benign equipment: the electrical equipment associated with the MIU/e are one or more Ex d switch(es) used within the MiniPurge Control system and terminated inside the MIU/e at terminals suitable for the intended use. These circuits are not capable of generating or contributing to electromagnetic emission. These switches can operate without degradation in the presence of electromagnetic disturbance in their intended environment.

Electrical Equipment (Safety) Regulations 2016 (SI 2016/1101)

Mini Interface Units MIU/e are intended to be used in potentially explosive areas (hazardous areas) and are therefore excluded from the Regulation.

Pressure Equipment (Safety) Regulations 2016 (SI 2016/1105)

Mini Interface Units MIU/e are classified as not higher than Category I under article 13 of this Regulation and also intended for use in potentially explosive atmospheres and are therefore excluded from this Regulation.

Equipment and Protective Systems intended for use in Potentially Explosive Atmospheres Regulations, UKSI 2016:1107 (as amended) - Schedule 3A Part 1

Mini Interface Units MIU/e are designed to conform to the above Regulations in fulfilment of the Essential Health & Safety requirements of Annex II and in compliance with:

EN IEC 60079-0:2018 EN 60079-2:2014 EN 60079-31:2014

Mini Interface Units MIU/e are certified under UK Type-Examination Certificate CSAE 21UKEX1051X by CSA Group Testing UK Ltd. (UK Conformity Assessment Body No. 0518) in compliance with:

EN 60079-0:2012 + A11:2013 EN 60079-2:2014 EN 60079-31:2014

Mini Interface Units MIU/e are manufactured under Production Quality Assurance Notification CSAE 21 UKQAN 0005, issued by CSA Group Testing UK Ltd. (UK Conformity Assessment Body No. 0518).

Technical documentation and assessments are in the Expo Technologies confidential technical file SC027.

For and on behalf of Expo Technologies Ltd

John Paul De Beer
Managing Director

Date 15th December 2021



EU Authorized Representative:
ExpoPharma Engineering Services Ltd
46 Eastcote Drive, Little Island,
Co. Cork, T45 WR68 Ireland.
E EUAR@expopharma.ie

Manufacturer:
Expo Technologies Ltd
Unit 2, The Summit, Hanworth Road,
Sunbury-on-Thames, TW16 5DB, U.K.
E sales@expoworldwide.com

EU Declaration of Conformity



This is to declare that the products listed below are manufactured in conformity with the following EU Directives under the sole authority of Expo Technologies Ltd:

Electronic Timer Modules Type ETM-IS**_***

The ETM-IS is a powered electronic timer module designed to be powered by a battery or power supply. The battery pack contains a non-rechargeable battery. The timer settings are controlled by two BCD switches. Connections from the timer to a switch to enable timing and a solenoid valve which is used to terminate the timing cycle are provided. The solenoid valve is supplied with the timer and battery or power supply (certified separately). Four LED's are used to indicate the status of the timer circuit.

Low Voltage Directive 2014/35/EU

Electronic Timer Modules Type ETM-IS**_*** are intended for use in potentially explosive atmospheres (Hazardous Areas) and are therefore excluded from the Low Voltage Directive.

ATEX Directive 2014/34/EU Equipment for explosive atmospheres

Electronic Timer Modules Type ETM-IS**_*** are designed to conform to the ATEX Directive in fulfilment of the essential health and safety requirements set out in Annex II, and in compliance with:

EN 60079-0: 2018

EN 60079-11: 2012

Electronic Timer Modules Type ETM-IS**_*** are certified by FM Approvals Europe Ltd. One Georges Quay Plaza, Dublin, Ireland. D02 E440, under EU Type-Examination Certificate FM10ATEX0003, in compliance with:

EN 60079-0: 2012 + A11:2013

EN 60079-11: 2012

Electronic Timer Modules Type ETM-IS**_*** are rated and shall be marked as follows:

Group II Category 1 G



Group II Category 1 D



Electronic Timer Modules Type ETM-IS**_*** are manufactured under Production Quality Assurance Notification SIRA 99 ATEX M043, issued by CSA Group Netherlands B.V. (CSA), Notified Body No 2813.

Signed for and on behalf of Expo Technologies Ltd.,

John Paul De Beer
Managing Director

Date 2nd November 2021
Confidential Assessment file reference SC039

SC039 Electronic Timer EU DoC Issue 4



日燭科技有限公司
JD Auspice Co., Ltd.



 www.jdauspice.com



 [@jdauspice](https://www.facebook.com/jdauspice)



 ID : @jdapv

